

# London Gateway Logistics Park Local Development Order 2

## Appendix 3: Design Code

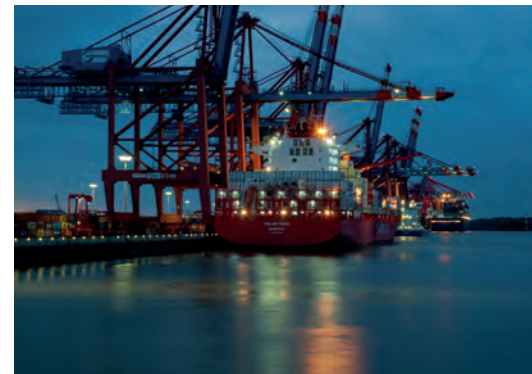

December 2024

## London Gateway Park Local Development Order 2

### Design Code

<b>Contents</b>		Page
<b>Introduction</b>		4
<b>Part 1: Plot Design Standards for General Industry, Storage and Distribution, Research and Development and Light Industrial</b>		8
<b>A</b>	<b>Plots and Building Design Standards</b>	8
A1	Plots	8
A2	Building Size	8
A3	Height	10
A4	General Cladding and Roofing Principles	12
A5	Dock Levellers and Level Access Doors	14
A6	Ancillary Office Accommodation	14
A7	Roofscape and Plant	14
A8	Gatehouses	15
A9	External Building and Site Signage	15
A10	Sustainable Design Standards	15
<b>B</b>	<b>Roads, Parking and Access</b>	16
B1	Plot Access	16
B2	Plot Based Vehicle Servicing	16
B3	Parking Standards	17
B4	Lorry Parking	20
B5	Cycle Parking	20
B6	Materials	21
B7	Standards for Footpaths and Cycleways	21
B8	Lighting	22
B9	Plot-by-Plot Rail Connection	28
<b>C</b>	<b>Landscaping</b>	30
C1	Street Furniture	30
C2	Boundary Treatments	30
C3	Feature Elements	31
C4	Soft Landscaping	32
C5	Landscape Management Plan	38
C6	External Finishes	38
C7	Earth Shaping and Planting Regime	38
<b>D</b>	<b>External Areas</b>	39
D1	External Storage	39
D2	Ancillary Infrastructure	39
<b>E</b>	<b>On Plot Drainage Standards</b>	41
E0	Overview	41
E1	Foul Water Drainage and Treatment	41
E2	Surface Water Drainage	43
E3	Pollution Control	46

<b>Part 2: Plot Design Standards for Offices, Food and Drink, Shop, Gym, Creche/Day Nursery and Outdoor Sports Facilities</b>	48
<b>F Plot and Building Design Standards</b>	48
F1 Plots	48
F2 Building Size	48
F3 Height	48
F4 Building Materials and Roofing Principles	49
F5 Roofing and Plant	49
F6 Fixed Plant	49
F7 Ventilation and Extraction for Premises serving Hot Food	50
F8 External Building and Site Signage	50
F9 Sustainable Design Standards	51
F10 Creche/ Day Nursery (Use Class E(f))	51
F11 Outdoor Sports Facilities (Use Class F2 (c))	52
<b>G Roads, Parking and Access</b>	53
G1 Plot Access	53
G2 Plot / Amenity Hub Based Vehicle Servicing	53
G3 Parking Standards	53
G4 Cycle Parking	56
G5 Materials for Road Construction	56
G6 Standards for Footpaths and Cycleways	56
<b>H Lighting</b>	56
<b>I Landscaping</b>	58
I1 Street Furniture	58
I2 External Amenity Space	58
I3 Boundary Treatment	59
I4 Feature Elements	59
I5 Soft Landscaping	59
I6 Landscape Management Plan	60
I7 External Finishes	60
I8 Earth Shaping and Planting Regime	60
<b>J Ancillary Infrastructure</b>	60
<b>K On Plot Drainage Standards</b>	60
<b>Part 3: Infrastructure Standards</b>	62
<b>L Highway Design Standards</b>	62
L1 Internal Access Roads	62
L2 Road Drainage	64
L3 Pollution Control	66
L4 Materials	66
L5 Bus Routes and Facilities	67
L6 Soft Landscaping	67
L7 Lighting Requirements	69
L8 Signage	71
L9 Emergency Access	71

## Design Code

<b>M</b>	<b>Park Drainage Standards</b>	71
M1	Surface Water Drainage	71
M2	Swales	71
M3	Standby Generator	73
M4	Pollution Control	73
M5	Operation and Maintenance	74
<b>N</b>	<b>Land Raising</b>	74
N1	Land Raising	74
<b>O</b>	<b>General Landscaping Requirements</b>	74
O1	Soft Landscape Specification	74
O2	Edge of Site	74
O3	Street Furniture, Boundary Treatments & Feature Elements	74
O4	Landscape Management Plan	76
<b>P</b>	<b>Services Infrastructure</b>	77
P1	Gas Supply	77
P2	Potable and Non Potable Water Supply	77
P3	Electricity Supply	77
P4	Telecommunications	77
P5	Fire Fighting Systems	77
P6	Utility Infrastructure	78
P7	Sub Stations, Pumping Houses and Other Non-commercial Buildings	78
P8	HGV Fuel and Wash Facilities Serving the Park	78

## Appendices

Appendix 1:	Soft Landscaping Specification
Appendix 2:	Landscape Management Plan
Appendix 3:	Terms of Reference for London Gateway Services Ltd

## **Introduction**

1. This London Gateway Logistics Park Design Code forms part of the London Gateway Logistics Park Local Development Order 2 (referred to as LDO2) and must be read in conjunction with it.
2. The Design Code sets out the minimum standards to be applied to the building plots, infrastructure and amenity space on site developed pursuant to LDO2. Its purpose is to ensure that a high and consistent standard of design is maintained throughout the logistics park to provide a sustainable and stimulating working environment whilst at the same time enabling the diverse requirements of individual occupiers to be met.
3. Development must accord with all aspects of Part 1, Part 2 and Part 3 of the Design Code in order to benefit from the permitted development rights conferred by LDO2. For the avoidance of doubt, matters discussed in this Introduction are for contextual purposes only.
4. Where herein reference is made to adopted guidance, standards or codes, any such updates to that guidance, standard or code shall apply.

### *The Logistics Park*

5. Figure 1 shows the development status of the Park as of March 2024 including the arrangement of routes and spaces that provide the structure for the Logistics Park. Strategically located primary infrastructure corridors allow ongoing plot-by-plot development of the site. The development layout of the remaining plots to be developed is indicative and intended to be flexible and responsive to existing and future commercial requirements. The release of plots and associated infrastructure requirements shall be in response to commercial need.
6. Development along the northern boundary is characterised by smaller plots of varying depth and buildings restricted in height to no more than 16m to provide a graduation in scale between surrounding areas and the core of the site where larger distribution and industrial buildings up to 42m are to be located. Plots along the southern edge of the Park have the potential to be directly linked to the national rail network.
7. Infrastructure corridors accommodate primary and secondary roadways, cycleways and footpaths, and provide service zones for utilities and treated foul and surface water drainage. The positioning of the primary infrastructure corridors informs the precise location and maximum size of the building plots within the development.
8. The Park is accessed via the London Gateway Access Road to the west of the Site. This access road also serves the London Gateway Port. Gates 1, 2 and 3 shall provide emergency access to the Manorway for emergency vehicles, buses and operational vehicles during emergency scenarios.
9. Amenity spaces shall be linked by an infrastructure network to create an environment that will, over the lifetime of the development, continue to provide an attractive location for prospective investors and occupiers.



Figure 1: Development Status

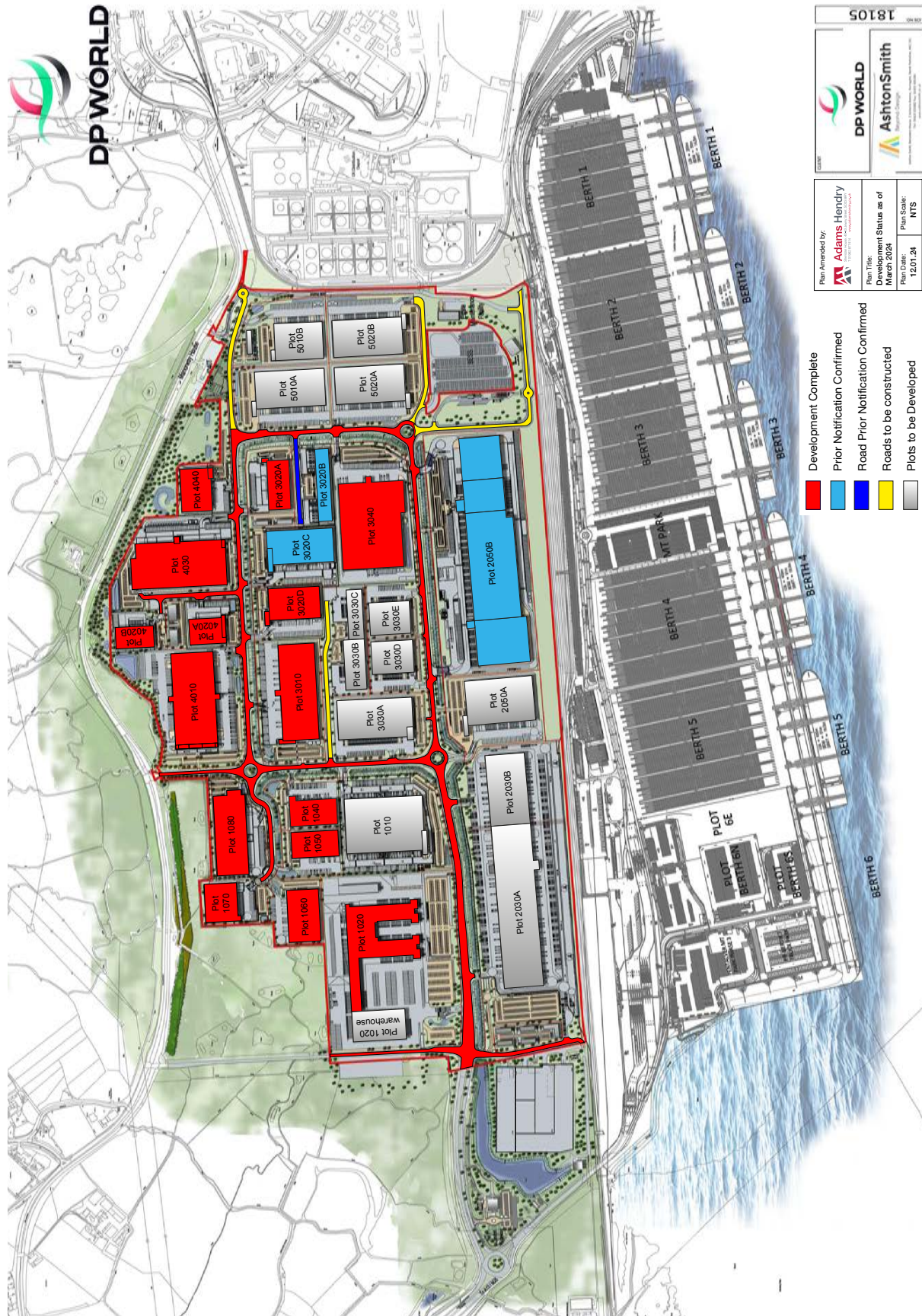

*Design Code*

*Phasing and Design*

10. The site is being developed on a plot-by-plot basis to suit operational requirements and accommodate commercial demand.

11. The rate of development of the logistics park is subject to market demand but shall continue to proceed in a controlled and co-ordinated manner in accordance with the Code of Construction Practice (CoCP) and associated legal agreements. Suitable plots to meet commercial requirements shall be released in a manner that does not compromise the delivery of the overall development and enables the necessary supporting infrastructure improvements to be bought forward in a timely manner.

12. Remaining building plots should be set out to maximise material efficiency, co-ordinate with standard warehouse racking systems as appropriate and ensure an appropriate development density can be achieved whilst maintaining parking, utilities, servicing, and hard and soft landscaping standards.

13. Where appropriate opportunities for public artwork to help orientate and provide interest to users shall be incorporated at key locations across the Park.

# **Part 1: Plot Design Standards General Industry, Storage and Distribution, Research and Development and Light Industrial**



## Part 1: Plot Design Standards for General Industry, Storage and Distribution, Research and Development and Light Industrial

### A Plot and Building Design Standards

#### A1 Plots

A1.1 An area of smaller scale development plots adjacent to the northern boundary shall generally provide sites for units with smaller footprint areas and standard, lower clear internal heights. The remainder of the site shall be released for buildings up to 150,000sq.m.

A1.2 Plots in the Health and Safety Executive (HSE) Inner Zones (IZ) for the petrol storage site and gas pipelines as shown on Figure 2 shall only be released where:

- the number of occupants in each building is less than 100 and the building has less than 3 occupied storeys.
- it will be used for parking (cars or HGVs) serving the Plot.

A1.3 Plots within the HSE Middle Zone (MZ) or Outer Zone (OZ) as shown on Figure 2 shall be limited to B8 use.

A1.4 No building classed as a 'vulnerable building' within the meaning of Schedule 5 to the Explosives Regulations 2014 (as amended or replaced from time to time) shall be constructed within the 'Envelope of Safeguarding Distances SD3' as shown in purple on Figure 2. In accordance with the regulations this applies to any building that is:

- (a) of more than three storeys above ground or 12m in height constructed with continuous non-load bearing curtain walling with individual glazed or frangible panels larger than 1.5 sq.m and extending over more than 50% or 120 sq.m of the surface of any elevation;
- (b) a building of more than three storeys above ground or 12m in height with solid walls and individual glass panes or frangible panels larger than 1.5 sq.m and extending over at least 50% of any elevation;
- (c) a building of more than 400 sq.m plan area with continuous or individual glazing panes larger than 1.5 sq.m extending over at least 50% or 120 sq.m of the plan area; or
- (d) any other structure that, in consequence of an event such as an explosion, may be susceptible to disproportionate damage such as progressive collapse.

A1.5 Should the extent of the HSE Zones, or the Envelope of Safeguarding Distances, shown on Figure 2 be subsequently revised, the relevant and most up to date restrictions will apply.

#### A2 Building Size

A2.1 The maximum gross internal floorspace of any single building within Use Classes B2, B8, E(g)(ii) and E(g)(iii) shall not exceed 150,000sq.m.

A2.2 The minimum gross internal floorspace of any single building within Use Classes B2, B8, E(g)(ii) and E(g)(iii) shall not be less than 1,000sq.m (unless for ancillary uses). For the avoidance of doubt, where a building provides for more than one business unit (i.e. a multi occupier building), each unit may comprise less than 1000Sq.m so long as the overall building is not less than 1000sq.m total floorspace.

Figure 2: HSE Consultation Zone

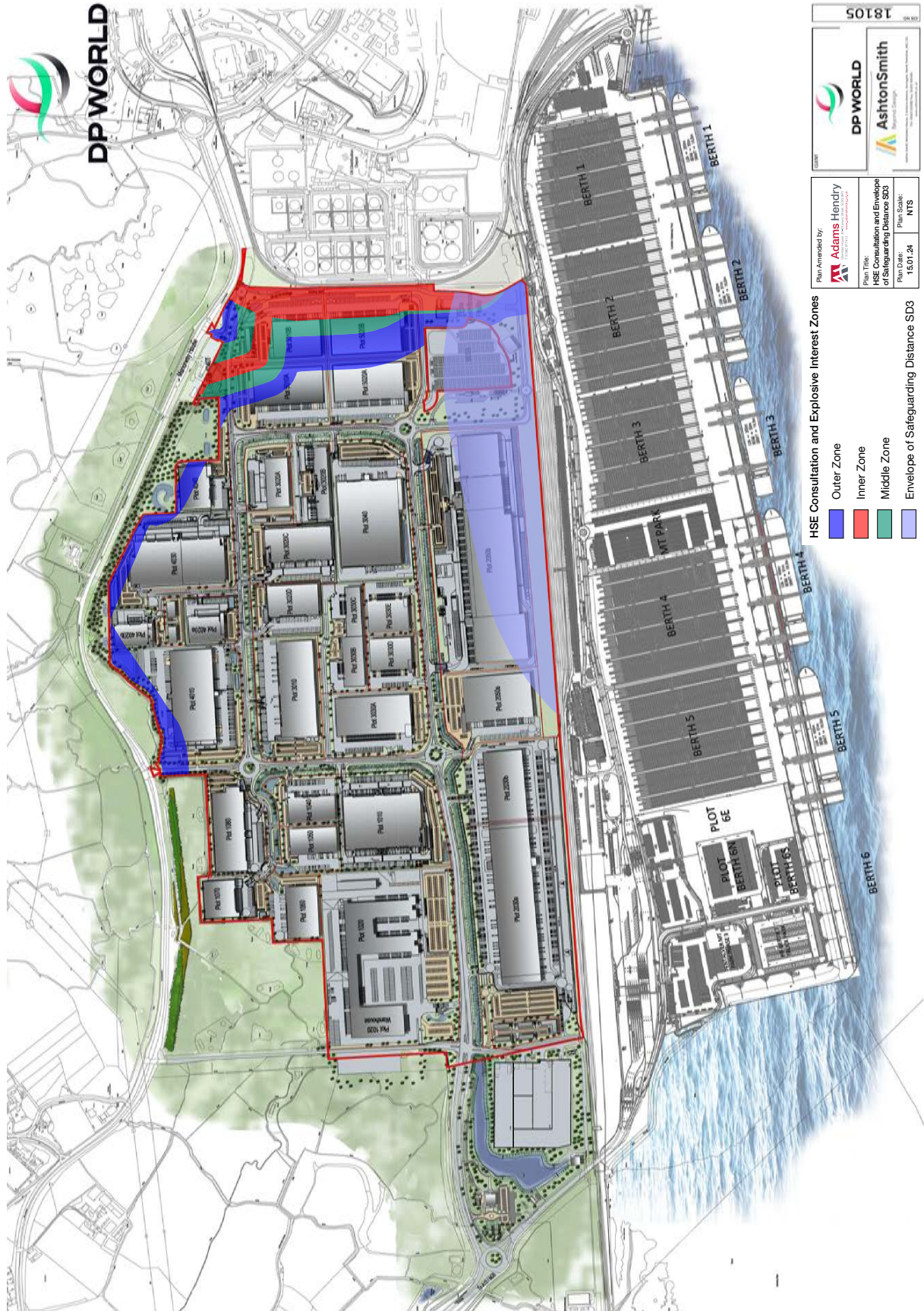

A2.3 'Gross Internal Floorspace' is equivalent to 'Gross Internal Area' as calculated in accordance with the RICS Code of Measuring Practice (sixth edition) or any revision thereto.

A2.4 Mezzanine floors shall contribute towards overall gross internal floorspace unless they are solely to provide for safe and efficient access to stacked or stored goods.

A2.5 Buildings shall maintain a minimum separation distance of at least 8m to the plot boundary.

### A3 Height

A3.1 Development shall not exceed the maximum height for the zone/plot in which the building is to be located as shown on the Height Zoning Plan (Figure 4) and shall not exceed the height in AOD set out below:

- 16m zone = 21.1 AOD
- 24m zone = 29.1 AOD
- 28m zone = 33.1 AOD
- 42m zone = 47.1 AOD

A3.2 Building height shall be measured from the warehouse finished floor slab (being generally between 1000mm and 1500mm above external levels to accommodate mechanical handling equipment – see Figure 3). Within this height there will be a clear internal height to haunch, roof pitch and (if required) 1100mm roof edge safety barrier zone. This measurement excludes nominal vent and flue protrusions up to 700mm above roof covering.

#### Finished Floor Levels

A3.3 Where dock level bays are required, the finished floor level (FFL) within the buildings shall be set between 1000mm and 1500mm above the ground level in the dock levelling bays.

**Figure 3: Building Height**

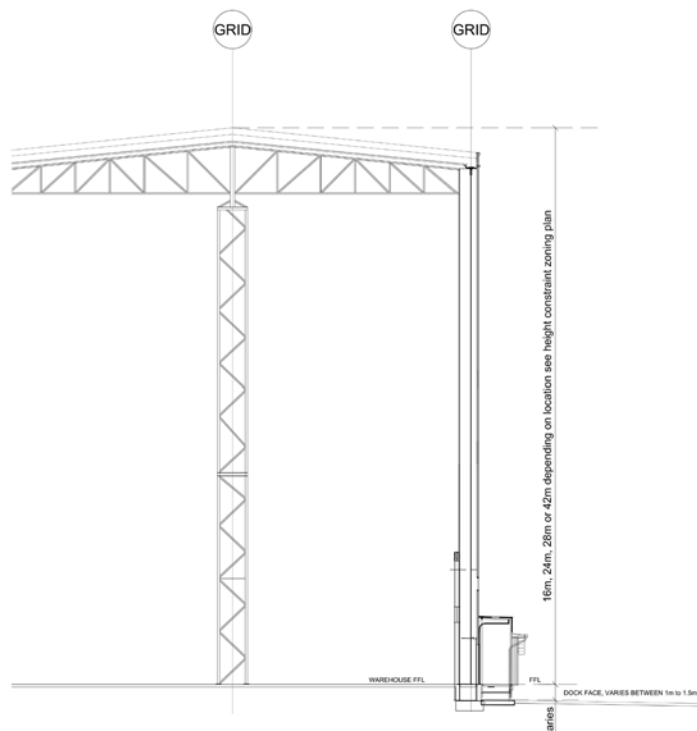
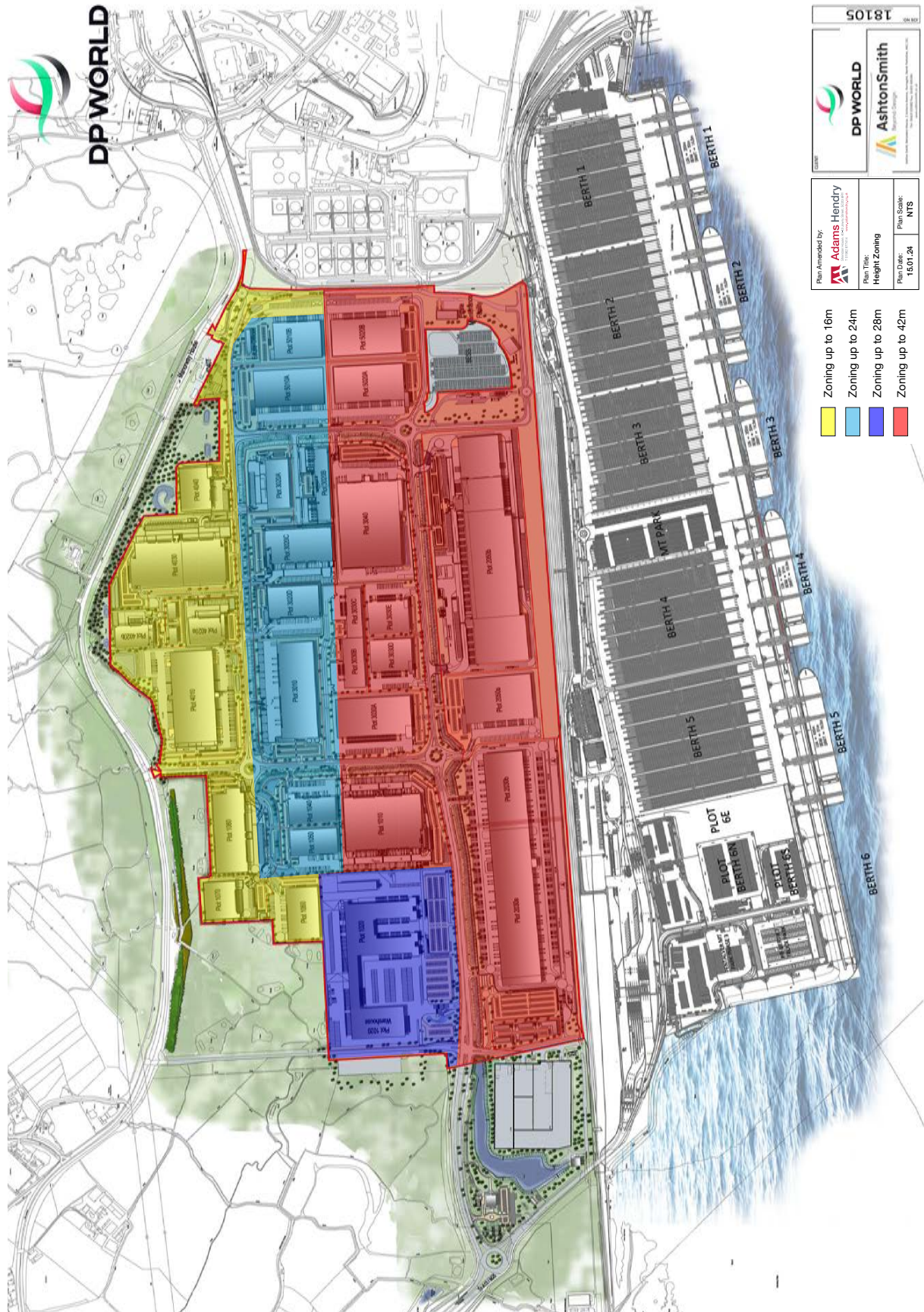



Figure 4: Height Zoning Plan



## A4 General Cladding and Roofing Principles

A4.1 A palette of different materials shall be used in order to achieve articulation and texture in the overall appearance of the area.

A4.2 The visual impact of the colours and finishes of wall and roof cladding materials shall be considered in relation to the background and context of the building.

A4.3 Where buildings over 100,000sq.m are proposed, colours and tones that differ from those of adjacent buildings shall be encouraged to help break up the collective visual mass of a group of buildings and give visual texture to the area when viewed from long distances.

A4.4 Elevations shall be divided horizontally above the door zone reducing the overall scale of the walls. A minimum of two different cladding profiles laid either horizontally or vertically and two complimenting cladding colours shall be used on both the warehouse and office elevations to achieve a level of consistent elevational treatment around the Park development. Individual occupier operational requirements for canopies over docking bays (if required) shall provide additional articulation of the elevations. Smaller areas of corporate colouration shall be reserved for office elevations fronting onto the infrastructure corridors.

A4.5 Elevations shall be punctuated with a range of coloured sectional overhead loading and access doors either at grade or in conjunction with lowered dock levelled service yards. At least one additional colour shall be selected from a manufacturers standard range of colours to compliment the warehouse cladding colour scheme and tie in with corporate colours on the office elevations.

A4.6 For buildings in the northern buffer zone as shown on Figure 5, the elevations that face sensitive surrounding areas shall be light in colour and shall reflect the treatment of other elevations as a minimum. The use of natural materials such as timber cladding on office elevations is encouraged. This design approach, along with the strategic use of landscaping, will allow the buildings to blend in with their surroundings. Elevations that have aspects onto the interior of the site can be of brighter colours to highlight company identity and complement port and introspective views. Where practical, the 'high bay' areas of distribution units to western and northern park boundaries shall be orientated towards the centre of the Site.

A4.7 Large industrial and warehouse units shall typically be constructed from either prefabricated composite insulated metal panels or sheets of profiled steel or aluminium, spanning between primary or secondary steel frames and cladding rails.

A4.8 External wall cladding shall be either composite panels, built up systems or similar fit for purpose cladding makeup. Colours shall be from the standard range set out below, achieving a 'u' value at least in compliance with building regulations.

### *HPS200 Cladding Finish*

Colorcoat HPS200 Ultra (or similar) with Galvalloy substrate and Confidex Guarantee from Tata Steel Standard colours with a minimum 25 year guarantee from the Signature, Classic and Matt colour ranges (appropriate in coastal locations) shall be selected.

### *Prisma Cladding Finish*

Colorcoat Prisma (or similar) with Galvalloy substrate and Confidex Guarantee from Tata Steel Standard colours with a minimum 25 year guarantee from the Solid and Metallic colour ranges (appropriate in coastal locations) shall be selected.



Figure 5: Northern Buffer Zone plan

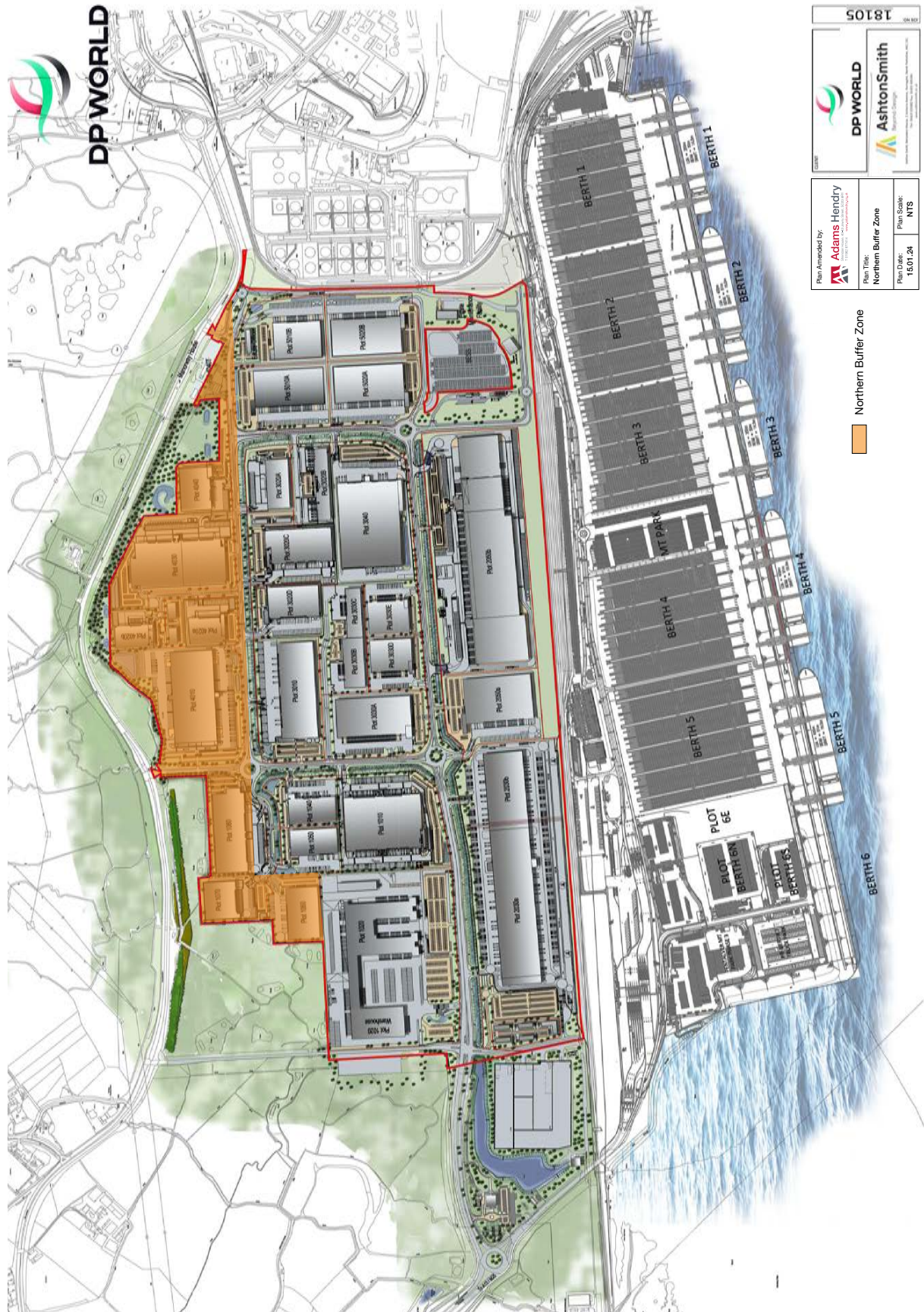

A4.9 Doors and dock sheltered openings shall be set within a plinth zone of cladding or pre-cast concrete panels designed to withstand or be protected from increased levels of impact damage and toned to integrate with the components at the base of the building and to reduce the overall visual mass of the structure.

A4.10 Vertical features such as exposed rainwater pipes and panel joints may be used to reduce the horizontal extent of any elevation and provide points of visual reference.

A4.11 Any extension or alteration to a building shall have a similar external appearance to the existing building.

## **A5 Dock Levellers and Level Access Doors**

A5.1 Dock levellers shall be provided, as required, with flexible shelters to minimise the ingress of air and water into the building. Shelters shall generally be black in colour. Insulated sectional overhead doors shall include safety windows and shall be coloured to suit the overall elevational treatment, or reflect corporate identity. The low level position of these features on the elevation shall allow the perimeter landscaping to provide effective screening.

## **A6 Ancillary Office Accommodation**

A6.1 Ancillary offices shall be designed to maximise the use of natural ventilation and light. Double depth offices with links into the main warehouse area, where required, would be acceptable.

A6.2 Ancillary offices shall be positioned on prominent elevations or corners of buildings fronting onto infrastructure corridors. Office elevations shall be distinctive to assist legibility for example through the use of entrance canopies or timber cladding. A freestanding office pod may also be provided on-plot provided it is 'purpose designed' to compliment the design of the principal building.

A6.3 Glazing shall be provided to all floors of the ancillary offices. Entrance door sets for staff and visitors may either be combined or separated to suit operational

## **A7 Roofscape and Plant**

A7.1 Roof planes set at a minimum pitch of 3 degrees and maximum pitch of 10 degrees shall generally be specified with roof lights at 15% where operational requirements permit, to provide natural light to the warehouse. Alternatively equivalent natural light may be provided by the inclusion of some translucent wall panels. Roof mounted plant excluding roof mounted PV, flues and vents shall require screening behind a parapet wall, or integration within office or warehouse components to maintain clean horizontal roofscapes.

A7.2 External roof cladding shall be either composite panels, built up systems or similar fit for purpose cladding makeup. Roof form and cladding colours should allow for variation in order to disaggregate the mass of roof areas but shall be light in colour. Colours from the standard range of colours referred to in paragraph A4.8 shall be selected and finished in non-reflective coatings.

## **Fixed Plant**

A7.3 Fixed plants such as chiller units on noise sensitive elements (considered most likely to be offices and restrooms) within and between each plot shall comply with appropriate British standards for these noise sensitive spaces, including BS8233:2014.

A7.4 The following measures shall be implemented:

- Primary outdoor fixed plant noise sources (e.g. chiller units) shall be located on the facade of warehouses facing into the site (south or east façade) or behind acoustic screening sufficient to cut the line-of-sight between source and the nearest residential receptor. Acoustic screening, where provided, shall have a minimum surface mass of 10 kg/m<sup>2</sup> and shall meet with the requirements of paragraph C2.8 of this Code.
- The cumulative sound power level from all outdoor fixed plant systems on each plot shall not exceed 105 dB L<sub>WA</sub>.
- Noise from air handling ventilation grilles shall be suitably attenuated through the provision of attenuators within the ductwork. The following sound pressure limits shall not be exceeded:
  - Grilles on the west elevation of the western and northern boundary plots shall not exceed 55 dB L<sub>Aeq,T</sub> at 1m;
  - Other grilles within plots located adjacent to the north and west LDO2 boundary shall not exceed 60 dB L<sub>Aeq,T</sub> at 1m; and
  - Grilles in all other locations: 70 dB L<sub>Aeq,T</sub> at 1m.
  - The above sound pressure limits apply for elevations with ventilation grilles up to a maximum grille area of 20 m<sup>2</sup> per elevation.
  - Where a greater grille area is required, the above sound pressure limits shall be reduced by 10\*log<sub>10</sub>(A/20) dB where A is the proposed total grille area per elevation.
- When considering the above, plot operators shall have due regard to the Control of Noise at Work Regulations and any requirement to control noise to ensure audibility of life-safety alarms or evacuation alerts.

A7.5 General working practices shall be put into place to minimise the levels of noise including:

- Awareness training for all staff on noise, particularly control of noise at night.
- Audit of the noise being generated during operations by foremen and steps taken to enhance the measures to control noise.
- The use of radios for communications instead of verbal instructions.
- Consideration of the use of alternatives to tonal reversing alarms such as through banksmen to avoid the need for alarms, or through the use of broadband reversing alarms.
- Controls of the use of vehicle horns (for emergency purposes only).

## **A8 Gatehouses**

A8.1 Gatehouses shall be constructed to the material specification or similar standard to that set out in Section A4.8.

## **A9 External Building and Site Signage**

A9.1 All signage and advertisements on the Site shall be subject to the Town and Country Planning (Control of Advertisements) (England) Regulations 2007 as amended.



## A10 Sustainable Design Standards

### *Decentralised, Renewable and Low-Carbon Energy Generation*

A10.1 All development shall be designed so as not to preclude connection to a decentralised, renewable or low carbon energy supply where possible.

A10.2 As a minimum, new development shall provide 20% of predicted energy requirements from all sources of decentralised and renewable or low-carbon energy, unless it can be demonstrated that it is not feasible or viable.

### *BREEAM Standards*

A10.3 Where appropriate buildings shall achieve as a minimum BREEAM Outstanding or other such revised standard as may be included in the Thurrock Local Plan or other local policy documents.

A10.4 These requirements may be relaxed where the developer is able to prove that they are not economically viable, rendering development of the site undeliverable.

A10.5 Where a building is to be extended or subject to a change of use, it should achieve no less than the equivalent BREEAM standard to that of the original building.

## B Roads, Parking and Access

B1.0 The following design standards shall apply to the construction of internal plot access roads, plot-based vehicle parking and servicing.

### B1 Plot Access

B1.1 The design of access roads into individual development plots shall comply with the standards for access visibility set out in the Design Manual for Roads and Bridges (DMRB).

B1.2 Where practical or viable, pedestrian, cycle and car access to individual plots from the internal site highway network shall be designed to provide separation from goods vehicles and rail routes, for safety and security purposes and to prevent queuing of goods vehicles on the estate roads.

B1.3 Where practical or viable, plot accesses onto the road will be a minimum of 90m apart when on the same side of the road.

B1.4 To meet health, safety and security requirements on development plots, footpaths and cycleways shall be terminated at the plot threshold and internal plot layouts shall be designed to accommodate individual occupier requirements whilst maintaining safe routes to the buildings for pedestrians.

B1.5 Security fences or gates shall not obscure sight lines of any junction on the estate roads or any vehicular access to the highway.

### Gatehouses

B1.6 Security gatehouses and/or security gates shall be designed to accommodate incoming queuing goods vehicles whilst maintaining a free flow of cars and cycles to designated parking

areas. For plots providing greater than 15,000sq.m GIA of total floorspace, security gatehouses and/or security gates at the entrance to individual plots shall be set back to enable at least two HGVs to pull off the highway to avoid queuing on any of the infrastructure corridors.

## **B2 Plot Based Vehicle Servicing**

B2.1 The internal plot circulation may be designed to allow cross docking to the larger units. Full site circulation and perimeter access for fire and service vehicles shall be maintained on larger units over 24,000sqm in compliance with Building Regulation requirements.

B2.2 Smaller units may be designed with single sided access and a reduced percentage of perimeter circulation that is accessible by fire and rescue service vehicles in accordance with Building Regulation requirements.

B2.3 HGV parking and yard circulation areas shall be in accordance with the recommendations of the Freight Transport Association - Designing for Deliveries 2016 (or as otherwise amended). HGV parking spaces shall be in accordance with the standards in Table 5. Articulated HGVs shall have a 20m pullout/yard circulation zone, unless tracking drawings are provided demonstrating that suitable HGV turning and manoeuvring can be achieved within a reduced pull out area.

B2.4 HGV circulation on plot shall be designed to allow free flowing circulation to all external areas of the building required by the unit operator, either through the service yards or via a minimum 7.3m wide plot circulation roads.

B2.5 Where fire escape routes from buildings open onto service yard areas, protected escape steps and refuges shall be provided between lorry docking and parking bays.

### **HGV Fuel facility**

B2.6 All areas of hard standing shall be provided with a surface water drainage system fitted with oil and petrol interceptors and installation of a penstock(s) as appropriate for spill management.

B2.7 On plot HGV fuelling facilities shall not exceed a maximum plot coverage of 3% or 3,000 sq.m whichever is the lesser. Fuel storage tanks shall be double skinned and may be either below or above ground. Fuelling pumps shall be covered with a canopy with a minimum clear height of 6m and a maximum height to the top of the canopy of 9m. On plot HGV fuelling facilities shall be located in service yards or adjacent to on-plot circulation routes provided they are appropriately screened with a hedge or fence of at least 2m.

### **HGV Wash facility**

B2.8 On plot HGV wash facilities shall not exceed a maximum plot coverage of 1% or 1,000 sq.m whichever is the lesser. Wash facilities may either be open or covered with a maximum height to the top of the enclosure of 7m. However, surface water shall be excluded from the wash system, so a covered area would be preferable. Wash facilities shall be contained and not connected to the plot surface water drainage, unless agreed in writing with the Environment Agency. Alternatively, this run-off shall be treated as trade effluent, and shall be isolated and taken off site for disposal at a licensed facility.



### B3 Parking Standards

B3.1 Individual development plots shall be designed to achieve optimum vehicle parking requirements and to prevent vehicles queuing on the highway while waiting to enter the development plots.

B3.2 Car parking shall be provided on each plot in accordance with the maximum standards specified in Tables 1 – 5 below and shall be made available for use during the whole of the time that any part of a building is open to any persons employed within the building or to persons visiting the building. These standards will apply until such time as they are updated by Thurrock Council in which case the updated standards would apply.

B3.3 Dedicated and conveniently located parking spaces with charging points and facilities for the charging of electric vehicles shall be provided. Standards for electric vehicles, cycle, blue badge holders and motorcycles are minimum standards.

B3.4 Passive charging spaces shall be activated in line with occupier demand having regard to the use of car parking spaces dedicated for electric vehicle parking which is to be surveyed and reported in the annual survey in line with the Travel Plan.

B3.5 If ancillary office accommodation is included in the development, then a E(g) parking standard shall be applied for that area.

B3.6 Where a development incorporates two or more land uses to which different parking standards are applicable, the standard appropriate to each use shall be applied in proportion to the extent of the respective use.

B3.7 The width of standard parking bays with end bays adjacent to solid structures shall be increased by 1m to allow for manoeuvrability on entry/exit to and from the vehicle. Clear directional marking signs shall be set out using suitable signs and surface arrows.

B3.8 Landscaping shall be incorporated into parking areas as set out in C4 of this Design Guide.

**Table 1 - Parking Standards for use class B2 General Industrial**

Car	Electric car charging points	Cycle	Blue Badge	Motorcycle
1 space per 50 sq.m	50 spaces or fewer = 1 space with charging point  Over 50 spaces = 2% of total spaces with charging points.  Passive provision for all remaining spaces regardless of total number.	1 space per 250 sq.m for staff plus 1 space per 500 sq.m for visitors.  Passive provision for e-bike charging for all spaces regardless of total number.	200 vehicle spaces or less = 2 spaces or 5% of total capacity (whichever is greater)  Over 200 car spaces = 6 spaces plus 2% of total capacity	1 space + 1 per 20 car spaces (for first 100 car spaces); then  1 space per 30 car spaces (over 100 car spaces)  Passive provision for e-motorcycle charging for all spaces regardless of total number.

**Table 2 - Parking Standards for use class B8 Storage and Distribution**

Car	Electric car charging points	Cycle	Blue Badge	Motorcycle
1 space per 150 sq.m	1 space with charging point  Over 50 spaces = 2% of total spaces with charging points  Passive provision for all remaining spaces	1 space per 500 sq.m for staff plus 1 space per 1000 sq.m for visitors.  Passive provision for e-bike charging for all spaces regardless of total number.	200 vehicle spaces or less = 2 spaces or 5% of total capacity (whichever is greater)  Over 200 car spaces = 6 spaces plus 2% of total capacity	1 space + 1 per 20 car spaces (for first 100 car spaces); then  1 space per 30 car spaces (over 100 car spaces)  Passive provision for e-motorcycle charging for all spaces regardless of total number.

**Table 3 - Parking Standards for use class E(g) ((i) Offices, (ii) Research and Development, (iii) Industrial Processes)**

Car	Electric car charging points	Cycle	Blue Badge	Motorcycle
1 space per 30 sq.m	50 spaces or fewer = 1 space with charging point  Over 50 spaces = 2% of total spaces with charging points  Passive provision for all remaining spaces	1 space per 100 sq.m for staff plus 1 space per 200 sq.m for visitors.  Passive provision for e-bike charging for all spaces regardless of total number.	200 vehicle spaces or less = 2 spaces or 5% of total capacity (whichever is greater)  Over 200 car spaces = 6 spaces plus 2% of total capacity	1 space + 1 per 20 car spaces (for first 100 car spaces); then  1 space per 30 car spaces (over 100 car spaces)  Passive provision for e-motorcycle charging for all spaces regardless of total number.

B3.9 In addition to providing parking for disabled drivers as described in the code of practice BS8300:2009 (including amendments), a parking priority scheme for car sharers shall be implemented in line with the requirements of the LDO2 Travel Plan. Space for people with disabilities shall be located adjacent to entrances and shall be marked with lines and the International Symbol for Access.

**Table 4: Car Parking Dimensions**

Type	Dimensions
Standard	2.5m x 5.5m
Blue Badge	3.9m x 6.5m

## B4 Lorry Parking

B4.1 HGV parking shall be based on operational requirements. Parking bay dimensions shall be in accordance with the standards set out in Table 5.

**Table 5: Lorry Parking Bay Dimensions**

Type	Dimensions
Minimum for Vans	3.5m x 7.5m
Articulated HGVs	3.5m x 17m
Rigid HGVs	3.5m x 12m

B4.2 There shall be no parking on infrastructure corridors.

B4.3 For development in excess of 30,000 sq.m where 24-hour operation is required, welfare facilities (comprising showers, changing facilities and a food preparation area) shall be provided within the plot for drivers of commercial vehicles based on an assumption of one driver/ commercial vehicle per 3,500 sq.m. If such facilities are unable to be provided on plot (or if there is a shortfall in on plot provision), alternative facilities shall be provided off-plot at an equivalent rate.

## B5 Cycle Parking

B5.1 All cycle parking shall:

- be secure and covered;
- be conveniently located adjacent to entrances to buildings;
- enjoy natural observation;
- be easily accessible from roads/and or cycle routes;
- be well lit;
- be located so not to obstruct pedestrian and cycle routes.

B5.2 Sheffield stands shall be provided. Provision shall be made for lockers, changing and shower facilities. The location, type and dimensions for cycle parking shall accord with the Essex Parking Standards 2009 or other such standards adopted by Thurrock Council.

B5.3 Cycle stands shall be manufactured in galvanized steel or brushed grade 316 stainless steel and root fixed below ground. They may include a horizontal bar for additional strength and security and should allow for two bikes per unit and be of hooped form.



B5.4 Cycle shelters shall be manufactured using a galvanized steel frame with galvanized steel, powder coated steel, laminated or tempered safety glass or FSC timber infill and roof

panels. Where appropriate shelters shall include lighting elements to ensure safety and visibility for users.



## B6 Materials

B6.1 Materials for road construction shall be compliant with the appropriate British Standard or other relevant specification.

B6.2 Development plot entrances shall be concrete, block paving or asphalt.

B6.3 Standard profile concrete kerbs shall be used adjacent to footpaths / cycleways and within car parking areas. High profile concrete kerbs shall be used within areas susceptible to HGV damage.

B6.4 Road marking and parking bays shall be demarcated in white or yellow thermoplastic paint, or alternatively, where the parking area surface comprises block paving, via the use of paving blocks of a distinctly different colour. Kerbs shall be used to provide protection to pedestrian areas and prevent damage to landscaped areas by vehicles.

B6.5 When available, suitably recycled, locally sourced or 'green energy' materials shall be used where these conform to the necessary performance standards or specification.

## B7 Standards for Footpaths and Cycleways

B7.1 Shared use footways/cycleways shall be a minimum width of 3m.

B7.2 Where footways/cycleways are liable to vehicle over-run, materials shall be restricted to:

- Bituminous materials to DMRB standards unless there is a need to match existing paths surfaced with Hot Rolled Asphalt (HRA).
- Resin bound material - Highways Authorities Product Approval Scheme (HAPAS) certified with a minimum design life of 25 years.
- Where appropriate, concrete block paving, including tumbled blocks, 100mm x 200mm x 80mm.

B7.3 Where the footway will not be over run or otherwise damaged by vehicles the following paving may be used in addition to that noted above.

- 400mm x 400mm x 65mm standard concrete paving slabs.
- 400mm x 400mm x 65mm textured concrete paving slabs.

## B8 Lighting

### *General Considerations*

B8.1 The following standards apply to all exterior lighting across the site. References to lighting equipment are indicative and may be amended subject to achieving the stated performance requirements.

B8.2 Lighting equipment when installed, shall meet the lighting constraints defined in Institution of Lighting Professionals (ILP) Guidance Notes GN01/21 for the control of obtrusive light for Environmental Zone 2 applicable to the location of the site (see Figure 6). Additional care shall be taken to minimise light spill and glare from any lighting installed by ensuring the correct luminaire is selected and installed correctly in line with the recommendations within CIE 150: 2017 and ILP GN01/21. The design shall ensure the mounting heights employed are the minimum necessary to achieve the lighting performance requirements. Horizontal illuminance levels shall not exceed 1.0 lux at 25m and 0.1 lux at 50m from the perimeter site boundary to the Park. When lighting levels are measured, meter readings shall be within tolerance as per BS667:2005 Table 2. Lighting calculations shall be provided with a maintenance factor of 1.0 to show initial luminous flux and building surfaces shall be modelled to reflect the construction and colour of cladding. A drawing showing isolux contours shall accompany a prior notification submission. The management company, London Gateway Services Limited (LGSL), shall monitor illuminance levels at 50m intervals at points 25m and 50m from the northern and western perimeter site boundaries on at least one occasion between 1 November and 1 March each year and monitoring reports shall be made available to the Ecological Advisory Group (EAG) on request. LGSL shall take whatever steps necessary to ensure compliance with the standards set out above. In the event that any remedial action is required it shall be completed within 6 months of receipt of monitoring results and LGSL shall undertake further monitoring within 2 months of remedial action to ensure that the levels are being complied with.

B8.3 Lighting controls shall be introduced so that all luminaires can be dimmed or switched off in defined work areas should operational conditions allow, subject to health and safety requirements. Examples being staff parking areas when not in use or outside of shift change times, perimeter pathways, yard areas, and circulation areas when not in use at a reduced lighting level.

B8.4 Lighting within the development shall use an LED light source with a Colour Rendering Index, Ra >70 throughout. LED chipsets should have a Correlated Colour Temperature (CCT) lower or equal to 3000K.

B8.5 All luminaires will utilise LED chipsets with a range of optical properties to provide area lighting, roadway lighting and pathway lighting. Column mounted “blade” style luminaires are preferred for plot circulatory roads, footpaths or car park lighting for aesthetic reasons. Lighting across the site shall maintain similar appearance.

### *Lighting Controls*

B8.6 The exterior lighting shall be centrally managed with control and self-monitoring systems. Controlling luminaires should have presence detection and light sensitivity. Typical systems include but are not restricted to Telensa, Thorlux Smartsan and blue tooth low energy (BLE) meshing systems.



Figure 6: Lighting Environmental Zones Plan

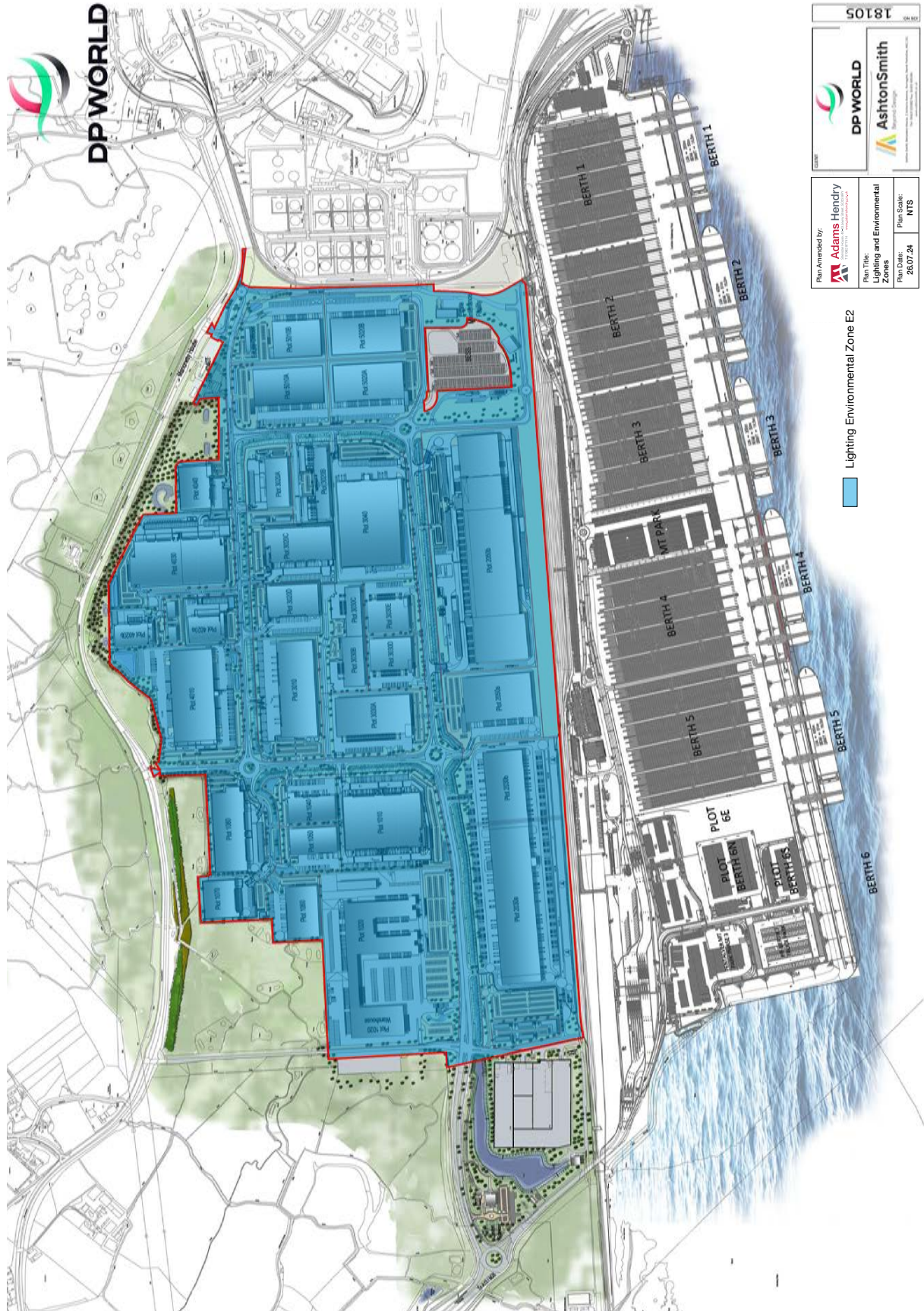

*Power Distribution*

B8.7 The exterior lighting shall be supplied by a private cable network fed from feeder pillars mounted externally or from distribution panels within the buildings.

B8.8 Where lighting units are mounted on walls of buildings, cabling shall be installed within corrosion and impact resistant conduit or trunking.

B8.9 Power supplies and cabling for lighting within the Park shall be fully segregated from Thurrock Council owned lighting equipment.

B8.10 Columns shall be mounted a safe distance from carriageways for maintenance access, free pedestrian and cycle passage and to reduce collisions in accordance with the requirements of clauses 3.3 and 3.4 respectively of TD501 of the Design Manual for Roads and Bridges (DMRB).

*Lighting Classes*

B8.11 The lighting classes for roads, footways and cycleways shall be as set out in BS 5489-1: 2020 Code of Practice for the Design of Road Lighting – Part 1: Lighting of roads and public amenity areas, or as subsequently modified, and BS EN13201:2015 Road Lighting. The lighting classes for outdoor work areas would be as set out in BS EN 12464-2:2014 Light and Lighting – Lighting of workplaces; Part 2: Outdoor work places.

**On Plot Circulatory Roads***Performance Requirements*

B8.12 The lighting of on plot circulatory roads shall be designed to lighting class P2 of BS EN 13201-2:2015. The performance requirement is:

Average illuminance, Eav:	10.0 to 15.0 lux
Minimum illuminance, Emin:	2.0 lux minimum

*Equipment Details*

B8.13 Light Source: LED with output to meet required class without overlighting with area optics such as the Thorlux Starbeam or equivalent.

Column Mounting:	8.0m - 10m with spacing and height optimised to meet the specified lighting class.
Mounting attitude:	Luminaires to have a default of 0 deg tilt to minimise upward light, however can have upto a 5 degree inclination to prevent excess backspill.

*Installation Geometry*

B8.14 Single Carriageway: Lighting columns shall be mounted in a single sided arrangement at the rear of the cycleway/footway with clearance as stated in BS5489-1:2020 at a spacing optimised to meet the specified lighting class.

## Lorry Docking and Loading Areas

B8.15 The lighting shall be in accordance with BS EN 12464-2: 2014 and in accordance with CIBSE LG06.

### *Performance Requirements*

Average illuminance:	50 lux
Overall Uniformity, U <sub>o</sub> :	0.40
Glare Rating Limit, GRL:	50

B8.16 Glare to a driver reversing a vehicle shall be avoided and shadowing caused by the vehicle load shall be considered. Glare visible outside the perimeter site boundary of the Park shall be avoided.

### *Lighting Arrangement*

B8.17 The lighting shall comprise column mounted or flood style LED luminaires such as the Thorlux Starbeam, with an output and spacing optimised to meet the lighting requirements. All floodlighting at this level should be mounted with a 0 degree tilt to avoid emitting upward light pollution or introducing glare. Spill shields to the rear of the fitting should be installed where optics may present excessive backward light.

B8.18 The lighting may be supplemented where necessary with wall mounted luminaires such as the Thorlux Realta 100% downlight with a lumen output of between 2000 and 3000 lumens at a maximum mounting height of 5.5m between each docking gate. Building mounted luminaires shall be at the lowest height to achieve the necessary illuminance / uniformity criteria. Care shall also be taken to ensure the luminance of building facades, taking into account the final cladding finish and reflectance, does not exceed that set out within ILP Guidance Notes for the Reduction of Obtrusive Light GN01:21 for the relevant Environmental Zone.

B8.19 In addition to the fixed exterior lighting, local adjustable lighting shall usually be provided at the docking gate within the building. This shall be switched locally and shall not operate once the docking gate is vacated.

## Distribution and Circulation Areas

### *Performance Requirements*

B8.20 The lorry circulation routes shall be lit to an average illuminance of 20 lux with a minimum overall uniformity of 0.40 in accordance with 5.1.3 of BS EN12464-2:2014 and CIBSE LG06.

### *Lighting Arrangement*

B8.21 Where the circulation route lies between the HGV parking area and the loading dock area, the lighting installed for those areas shall also provide sufficient lighting of the circulation route.

B8.22 Where the circulation route is adjacent to warehouses, a roadway optic column mounted luminaire such as the Thorlux Starbeam or equivalent with an output and spacing to achieve the specified lighting class may be used.



B8.23 Where there is no building directly adjacent to the circulation route, a roadway optic column mounted luminaire such as the Thorlux Starbeam or equivalent shall be used matching the style of lighting units employed on the access roads and car parks. Mounting heights and spacing should be optimised to meet the required lighting class.

B8.24 For wide circulation areas or areas designated as yard areas, perimeter lighting facing inwards shall be provided by column mounted luminaires such as the Thorlux Starbeam or equivalent with an output matching the style of other luminaires proposed on access roads and car parks. In very wide circulation areas supplementary lighting should be installed to 8.0m columns facing outwards to achieve required lighting levels. Columns should be protected from accidental damage.

## Weighbridges and Fuelling Areas

### Performance Requirements

B8.25 The level of lighting in these areas shall be increased compared to that on the general circulation areas. For the fuelling areas it may be necessary to use equipment rated for use in hazardous zones due the presence of explosive vapours unless the lighting is located outside of the hazardous zone. Lighting for specific tasks within these areas shall comply with the requirements of Table 5.6 of BS EN 12464-2:2014 and CIBSE LG06.

Average illuminance:	50 lux (external) / 150 lux (under canopy)
Overall Uniformity, U <sub>o</sub> :	0.40
Glare Rating Limit, GRL:	50 (external) / 45 (under canopy)

### Lighting Arrangement

B8.26 The lighting of weighbridges shall be provided by column mounted luminaires with such as the Thorlux Starbeam or equivalent with an output and mounting height matching the style of other luminaires proposed on access roads and car parks and optimised to meet the requirements of the chosen lighting class.

B8.27 The lighting of on plot HGV fuelling areas shall be provided by bulkhead type LED luminaires attached to the underside of the canopy.

## Gatehouses

### Performance requirements

B8.28 Gatehouses shall be lit to an average illuminance of 100 lux at ground level with a vertical illuminance at the level of the vehicle driver. Gatehouse security lighting shall be in accordance with the recommendations provided in sections 3.2.4 of CIBSE SLL Lighting Handbook (2018) as may be amended.

B8.29 The plot entrance shall be lit by multiple luminaires so that the loss of one luminaire will not seriously degrade the lighting available to the guard on duty. The lighting shall be positioned to enable sufficient illumination for the guards and CCTV to see the number plates of vehicles approaching the entrance.



*Lighting Arrangement*

B8.30 Lighting shall be provided by column mounted luminaires such as the Thorlux Starbeam or equivalent with an optimised output mounted on 8.0m -10m columns using an arrangement of twin and four way spigots, matching the style of other luminaires proposed on access roads and car parks. Consideration shall be given to providing back-up power supplies for these lighting units in the event of a power outage.

**Car and Van Parking Areas***Performance Requirements*

B8.31 The lighting of the car and van parking areas shall meet the requirements in Table 5 of BS 5489-1:2020 for outdoor car parks with medium traffic.

B8.32 The performance requirements shall be as follows:

Average illuminance, Eav:	10 lux
Overall Uniformity, Uo:	0.25 minimum

*Equipment Details*

Light Source:	LED luminaire providing an optimised output such as the Thorlux Starbeam or equivalent based on lighting class.
Optics:	Area Type
Column Mounting:	6.0m - 8m column, single & twin spigots where required.
Mounting attitude:	A default of 0 degree tilt should be used however a maximum of 5 degree can be used to achieve the required lighting class and reduce backwards light pollution while meeting the requirements of GN01.

*Installation Geometry*

B8.33 Lighting columns shall be provided around the perimeter of a car park and where necessary, within the central area of the parking area. Where lighting columns are located within the central area they shall be generally located on the raised islands at the end of parking space rows, or where it is necessary to position them between parking spaces, with barrier protection to protect vehicles manoeuvring into them.

**Lorry Parking Areas***Performance Requirements*

B8.34 The illuminance requirement shall be for 20 lux average and 5 lux minimum in accordance with "HSG 38 – Lighting at work" (HSE 1997).

B8.35 The lighting columns shall be positioned so that they will not be vulnerable to impact from HGVs reversing into the parking space and will not obstruct the tailgate of the trailer unit. They shall not cause glare visible outside the perimeter site boundary of the Park.

*Lighting Arrangement*

B8.36 The lighting shall comprise columns of 8.0m – 10m optimised maximum height positioned at the rear/perimeter of the parking area and located centrally between parking spaces at an optimised spacing. Glare shields shall be fitted to luminaires as required to reduce backwards light pollution and to provide a full cut-off of light above the horizontal. Columns shall be protected with barriers against HGV collision and not obstruct the tailgate of the trailer unit. Circulation routes within this area shall be lit from the designated column positions.

The performance requirements shall be as follows:

Average Illuminance: EAV 20lux  
Overall Uniformity: UO 0.25

*Equipment Details*

Light Source: LED luminaire with optimised output such as the Thorlux Starbeam or equivalent  
Optics: Area Type  
Column Mounting: 8.0m -10m column single and twin spigots where required.  
Mounting Attitude: A maximum of 5 degrees to reduce backward light pollution and achieve required lighting class while meeting the requirements of GN01.

**Boundary Security Lighting**

B8.37 Security lighting shall be in accordance with the principles and guidance detailed in Chapter 18 of the CIBSE SLL Lighting Handbook (2018) as may be amended.

*Performance Requirements*

B8.38 The lighting provided for security at boundary fences for secure areas shall provide an average illuminance of 5 lux with an overall uniformity of 0.1 at ground level on either side of the fence. Light sources with a colour rendering index, Ra, of at least 70 shall be used to provide good identification of colours. As set out at B8.2, horizontal illuminance levels shall not exceed 1.0 lux at 25m and 0.1 lux at 50m from the perimeter site boundary to the Park. When lighting levels are measured, meter readings should be within tolerance as per BS667:2005 – Table 2.

*Lighting Arrangement*

B8.39 Where buildings and other obstructions result in dark shadowing along the boundary, security lighting shall be provided by the lowest column to achieve the required results with columns up to 6.0m height, using luminaires up to 13,000 luminaire lumen output with a forward throw such as the Thorlux Starbeam or equivalent. The exact column height shall be dependent on the geography of the site and the type of fence construction. Where no building exists opposite the development, security light shall be provided with the use of 100% down light wall mounted luminaires at a maximum height of 3.0m.

**B9 Plot-by-Plot Rail Connection**

B9.1 No development shall take place within the Rail Safeguarding Area identified on Figure 7 that would prejudice the provision of rail access to the national rail network via the Thameshaven Branch Line. Sufficient space is required to accommodate the rail sidings and loading/unloading facilities as demonstrated with full tracking details of any container reach stacker (if proposed).

Figure 7: Area within which 50ha of land is to be safeguarded for Rail Access

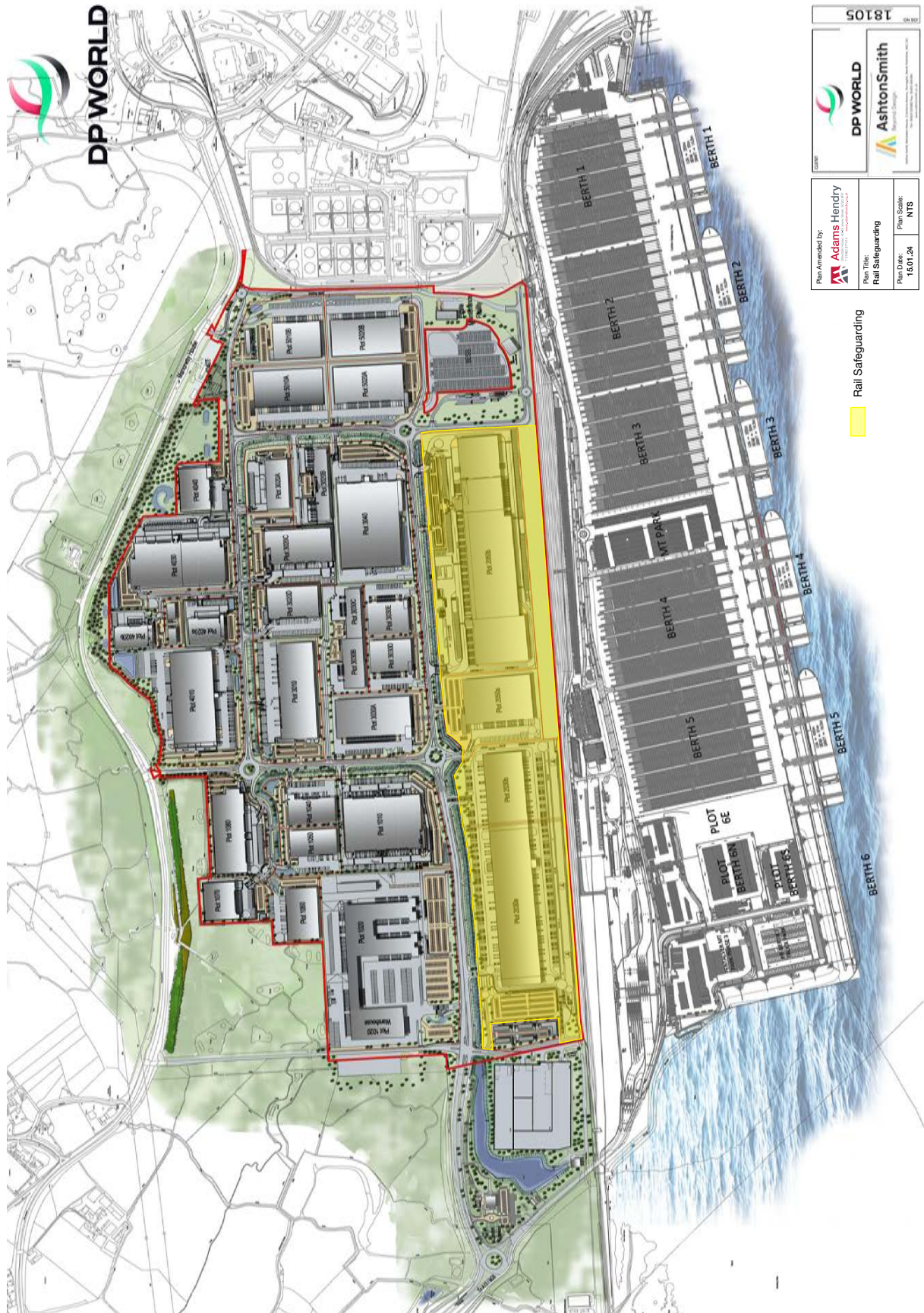



## C Landscaping

### C1 Street Furniture

C1.1 Street furniture (e.g. seating, cycle storage etc.) shall be in accordance with requirements set out at Part 3, Section O3 of this document.

### C2 Boundary Treatments

C2.1 Individual occupiers shall be responsible for on site security of their development plots. Fencing to the perimeter of each plot shall be designed to be unobtrusive within the perimeter of the landscaped zone, with the minimal amount of impact on landscaping unless the plot boundary is adjacent to another plot boundary in which case a shared perimeter boundary fence shall be set in a 1m gravel margin (see paragraph C4.8).

C2.2 Car parks to individual plots shall be designed to provide an element of natural surveillance allowing views from the road. Where practical or viable pedestrian, cycle and car access to individual plots from the highway network shall be designed to provide separation from goods vehicles and rail routes.

C2.3 The height of perimeter fencing shall be a maximum of 3m above ground level and shall typically be:

- BS1722-12 Steel Palisade Fencing; and
- BS1722- 14 Open Mesh Steel Panel Fencing Category 1 (General Purpose) and Category 2 (Security) Fencing.

C2.4 Posts and struts for all fences shall be manufactured from Black RAL9005 powder coated galvanised steel and secured with concrete foundations. All fixings and straining devices shall be zinc coated.

C2.5 All Steel Palisade fencing shall have pale tops shaped in accordance with BS1722-12. Fencing shall not have cranked arms, barbed tape concertina or barbed wire entanglement topping.

C2.6 Fencing shall closely reflect the ranges below:



C2.7 Other boundary demarcation requirements shall be determined in response to the individual needs of each plot. All boundary demarcation barriers throughout the development shall be constructed in accordance with BS guidance.



C2.8 Typical systems to be used across the development shall include:

- Wooden knee rail fencing;
- Car park barrier controls;
- Galvanised steel pedestrian barriers;
- Automated sliding gate systems;
- Timber demarcation bollards;
- Timber post and wire fencing;
- Timber post and rail fencing;
- Timber post and featherboard fencing (i.e. acoustic fencing).

C2.9 All timber elements shall be FSC certified. Finishes to metal elements shall be manufactured in Black RAL 9005 powder coated galvanised steel unless for hazard demarcation or similar.

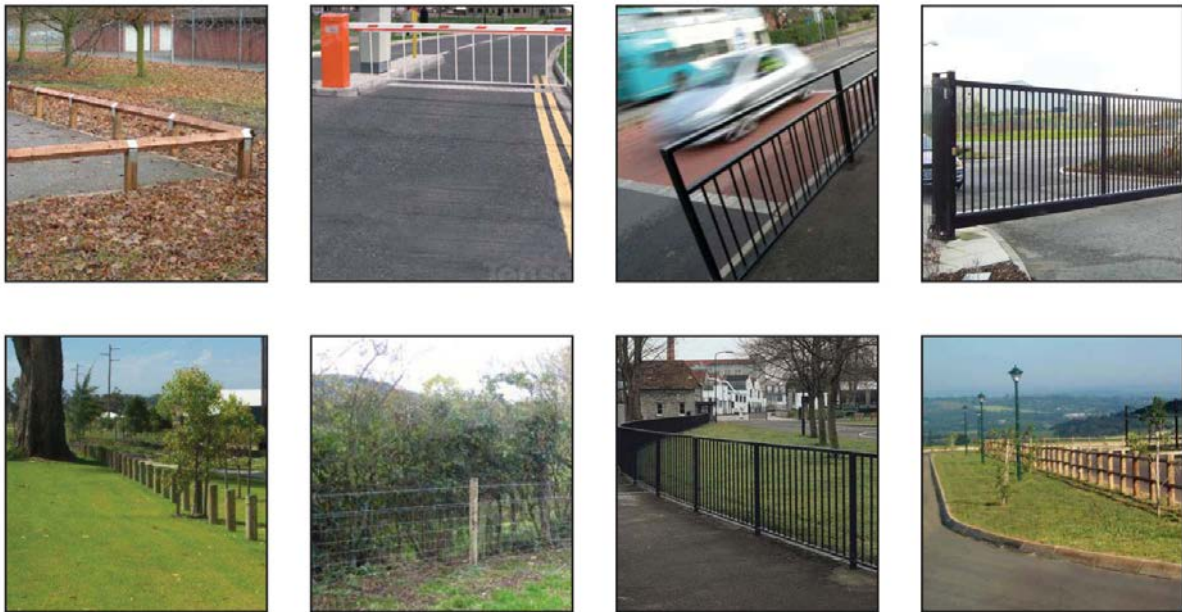

### C3 Feature Elements

C3.1 Lighting for landscaped areas for aesthetic effect may be provided. Examples of suitable products are shown in Table 6.

C3.2 Feature lighting (see Table 6) shall take account of the relevant lighting Environmental Zone classification of the plots location (see Figure 6) and be limited to the main entrance areas of plots and buildings.

C3.3 Colour and finish of lighting equipment shall be considered in the context of the environmental surroundings. The use of highly reflective finishes shall be avoided where these could cause a traffic hazard.

Table 6: Lighting Equipment

Product Image	Equipment Details	Typical Application
	<p>Thorlux Passway.</p> <p>Extruded aluminium body and die cast head, 500mm and 1.1m options, LED light source in 11 and 21w variations. Options for integrated emergency and controls.</p> <p>Part Code: PW19912LFCB830 or equivalent.</p>	Staff exterior seating areas and informal footpaths.
	<p>WEFF EFC.</p> <p>Stainless steel section, die cast housing balisage style recessed inground luminaire. LED light source in colour 3000 at 6W and 12W.</p> <p>Part Code: 185-2526 or equivalent.</p>	Wayfinding and guidance.
	<p>Performance IN Lighting Tyle+</p> <p>Die cast aluminium housing, multiple optical outputs with LED source in colour 3000k 7W through to 35W.</p> <p>Part code: 3107287 or equivalent.</p>	Highlighting and up lighting of trees and feature lighting.
	<p>Ledflex Ultimo Neon 16</p> <p>Silicone flexible led system with extruded aluminium housings available in colour 2200 – 4700k. Wattage varies according to length.</p> <p>Part code: 012-1362-SL or equivalent.</p>	Accent and colour bead lighting of building facades.

## C4 Soft Landscaping

C4.1 The on-plot soft landscaping scheme, except for the western and southern boundaries of the area shown on Figure 8, shall comprise deciduous and evergreen tree planting, native woodland/understorey planting, hedges, ornamental planting and seeding. The size of nursery tree stock shall range from transplants to semi-mature size and include a range of native and ornamental species suited to the site conditions and selected to optimise wildlife benefit and potential for habitat creation.

C4.2 A range of tree species shall be used that have a variety of canopy forms, leaf textures, seasonal colour and growth habits.

C4.3 The planting schemes shall take into consideration the required visibility for drivers, cyclists and pedestrians.

C4.4 The on-plot soft landscaping scheme for the western and southern boundaries of the area as shown on Figure 8 shall comprise a mosaic of short turf, bare ground and flowery swards. This is known as the 'mosaic landscaping area.'

C4.5 Within the mosaic landscaping area, the mosaic shall be created on very nutrient poor subsoils and will include a variety of substrate sizes, with bare ground comprising 20-50% of the habitat mosaic. The bare ground element will be topographically varied.

C4.6 Within the mosaic landscaping area a variety of species shall be planted within the short turf sward to include:

- Common bird's-foot trefoil (*Lotus corniculatus*);
- Hawkbits (*Leontodon* spp.);
- Other trefoils (Fabaceae including narrowed-leaved bird's foot trefoil (*Lotus tenuis*));
- Other vetches (*Vicia* spp.);
- Red clover (*Trifolium pratense*); and
- Yarrow (*Achillea millefolium*).

C4.7 Within the mosaic landscaping area to complement the bare ground and early succession community, a variety of tall flowery swards shall be planted to include the following species and/or groups:

- Common knapweed (*Centaurea nigra*);
- Bush vetch (*Vicia cracca*);
- Red bartsia (*Odontites vernus*);
- Wild carrot (*Daucus carota*);
- Ox-eye daisy (*Leucanthemum vulgare*); and
- Other trefoils (Fabaceae).

C4.8 On each individual plot, a minimum perimeter landscape width of 10m shall be provided adjacent to the infrastructure corridors (see Figures 9A and 92B) unless the plot boundary is:

- directly adjacent to a swale on same side of the infrastructure corridor as the plot, where a minimum perimeter landscape width of 7.5m shall be provided (see Figures 9C and 9D); or
- along the southern boundary of the area shown on Figure 8 where the minimum landscape width of 8m shall be provided; or
- adjacent to an infrastructure corridor with a secondary single access road (as shown on Figure 17) where a minimum landscape width of 5m shall be provided (see Figure 10A and 10B); or
- adjacent to another plot boundary, and provided buildings maintain a minimum separation distance of at least 8m to the respective plot boundaries, the plots shall be separated by shared 2.4m high palisade or paladin security fence with a 1m gravel margin (see Figure 11A and 11B). Surfacing between the fence and the building shall comprise either gravel, concrete, block paving, tarmac or species rich grass sward; or
- adjacent to car parks, except where car parks are adjacent to the western and southern boundaries of the area shown on Figure 8, where landscaping shall include native hedge, native understorey trees and a minimum 3.0m wide zone

of ornamental planting (see Figures 9A, 9D and 10A). Where screening service yards, except where service yards are adjacent to the western and southern boundaries of the area shown on Figure 8, landscaping shall include native hedgerow and native woodland planting (see Figures 9B, 9C and 10B); or

- adjacent to the Gate 3 access road where a minimum landscape width of 5m shall be provided along the eastern plot boundary (see Figure 12);
- adjacent to the BESS site where a minimum landscape width of 3m shall be provided along the eastern plot boundary (see Figure 13).

C4.9 Security fencing along infrastructure corridors shall be aligned towards the plot side of the landscape strip.

**Figure 8: Mosaic Landscaping Area**

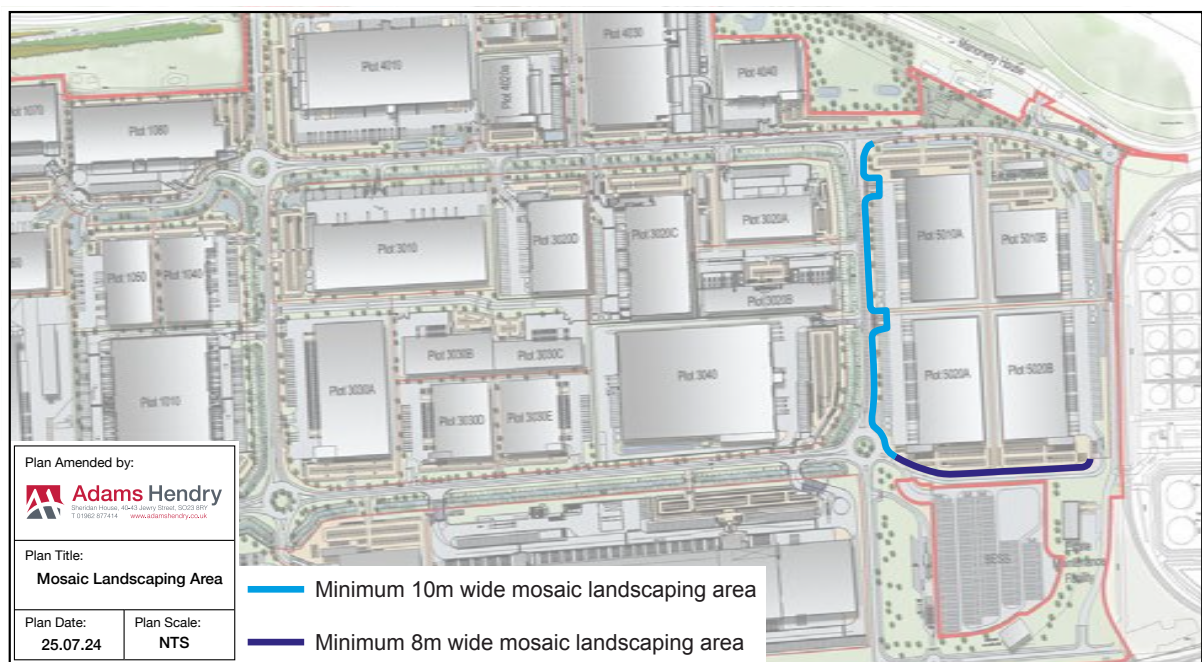

**Figure 9A: Perimeter landscaping between plot car parking and infrastructure corridors (10m width)**

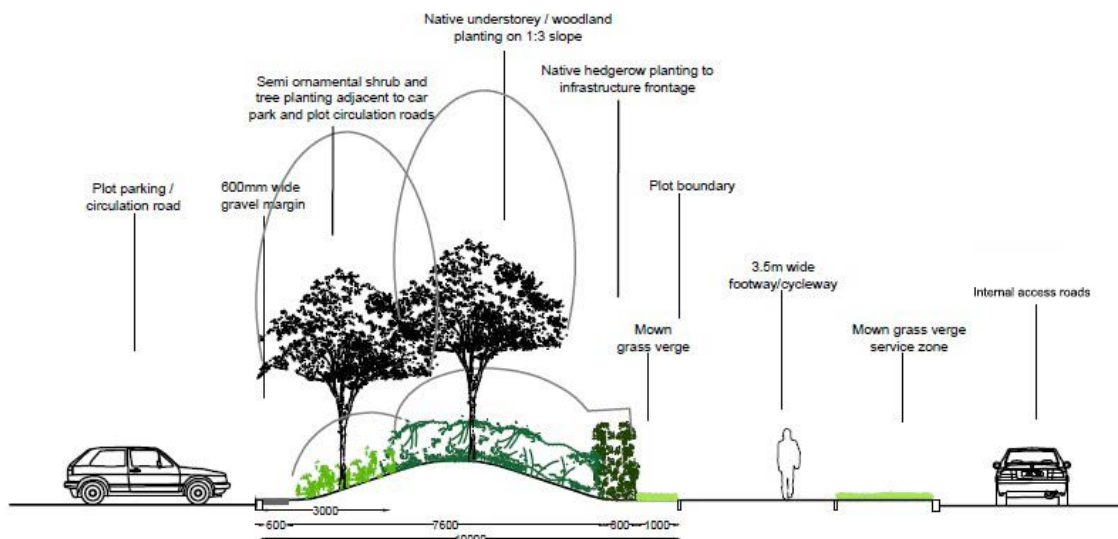



Figure 9B: Perimeter landscaping between plot HGV yard area and infrastructure corridors (10m width)

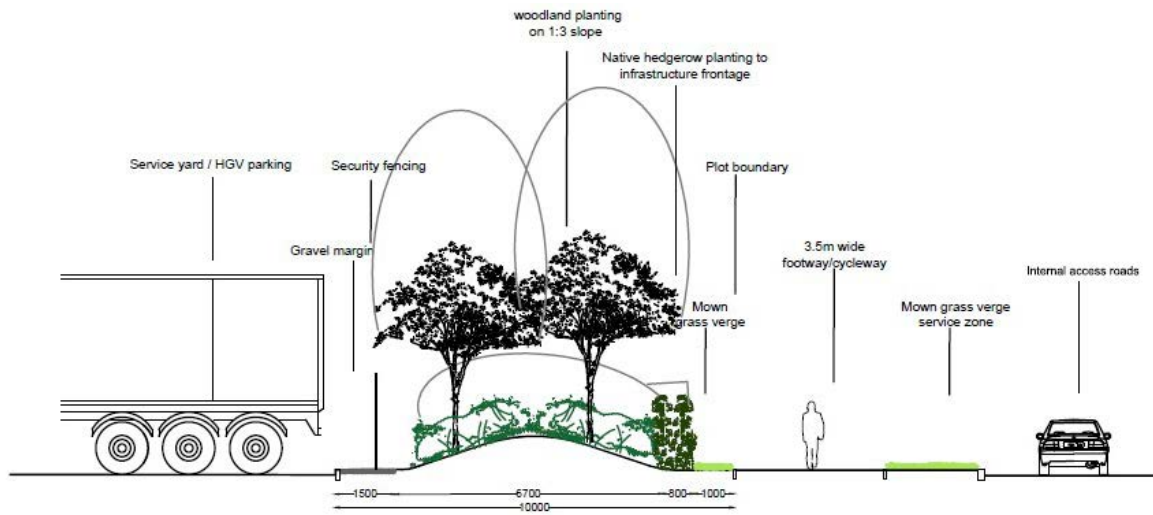

Figure 9C Perimeter landscaping adjacent to a swale between service yards and infrastructure corridors (7.5m)

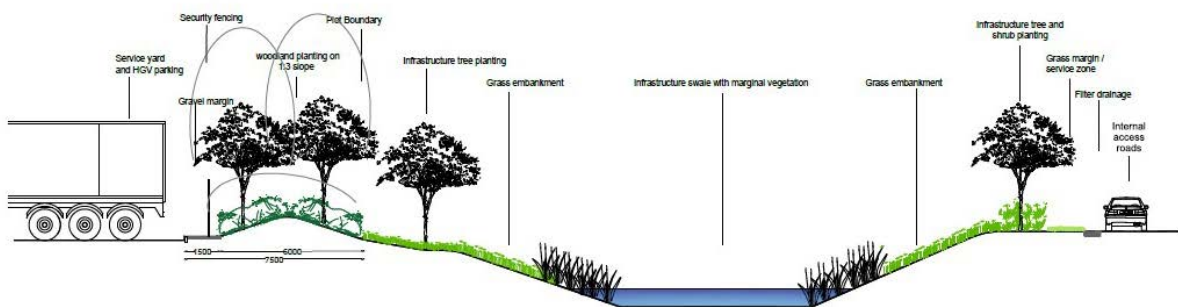
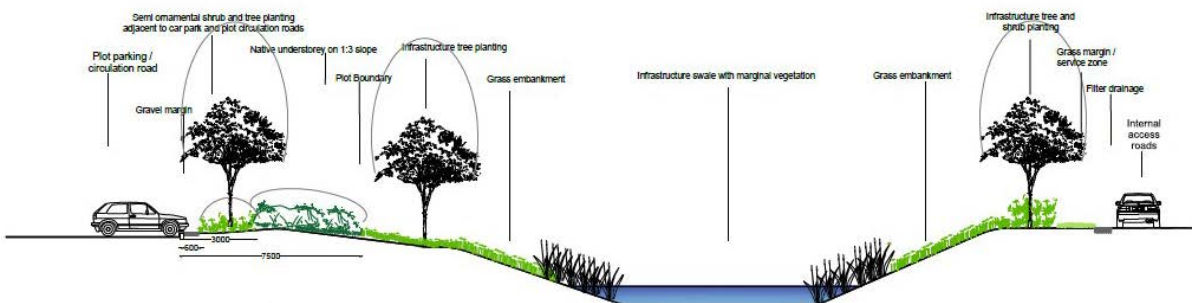
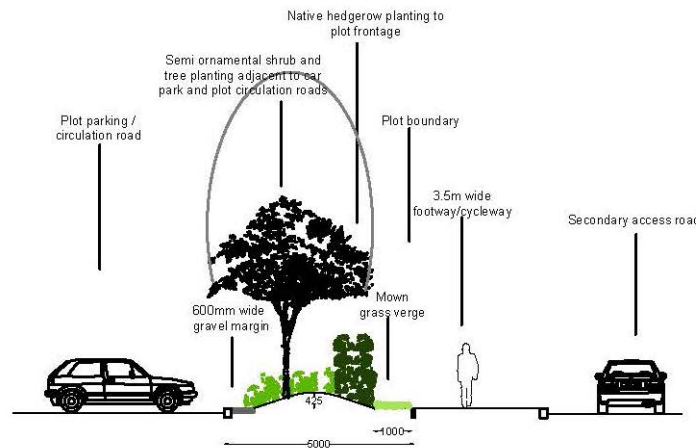

Figure 9D: Perimeter landscaping adjacent to a swale between plot parking/circulation road and infrastructure corridors (7.5m)



**Figure 10A: Landscaping where plot parking/plot circulation road adjacent to an infrastructure corridor with a secondary single access road (5m width)**



**Figure 10B: Landscaping where a service yard/HGV parking is adjacent to an infrastructure corridor with a secondary single access road (5m width)**

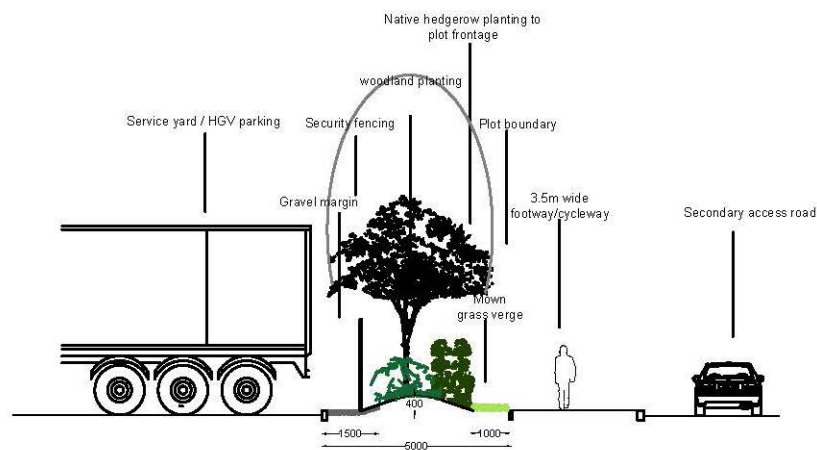

**Figure 11A: Shared site perimeter security fencing**

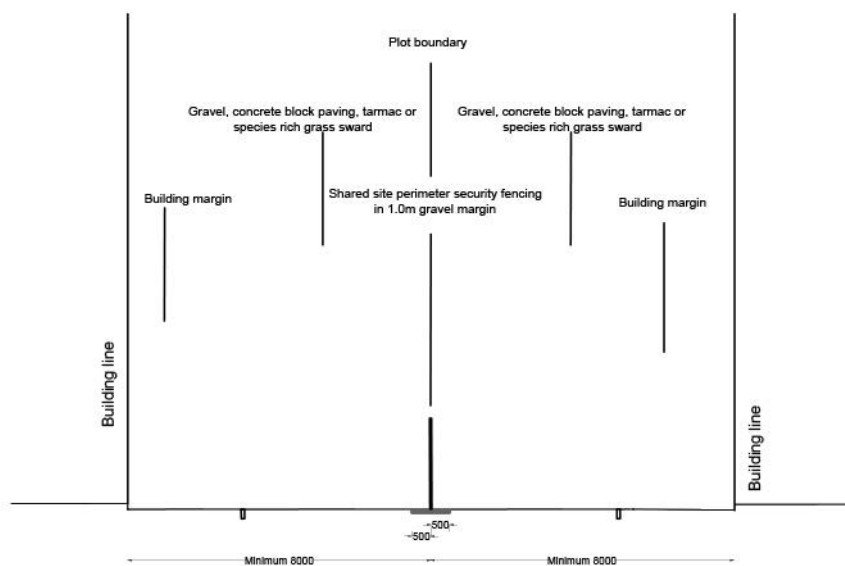

Figure 11B: Shared site perimeter security fencing adjacent to plot perimeter road/service yard

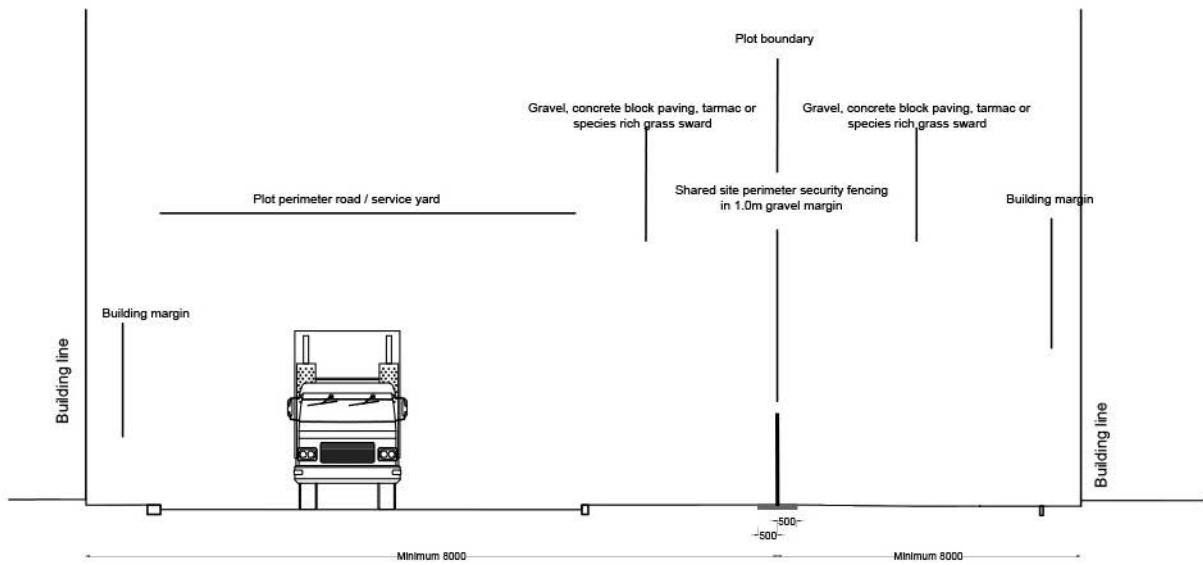

Figure 12: Typical cross section between Plots 5010A/5010B Arctic Avenue eastern boundary

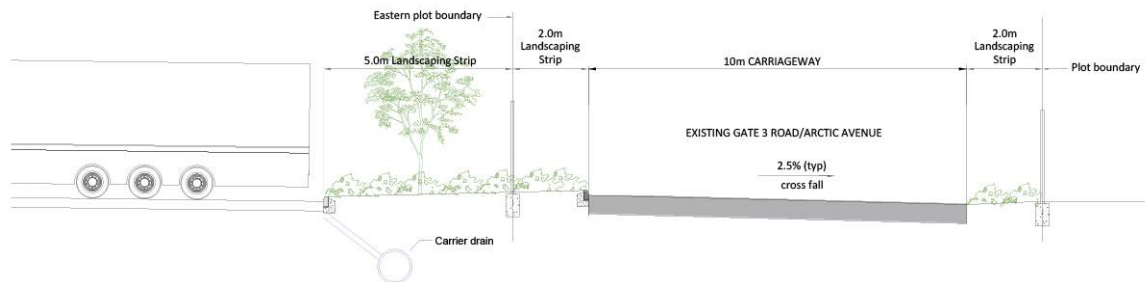

Figure 13: Typical cross section between development plot and BESS site



C4.10 Ornamental shrub, herbaceous and specimen tree planting shall be included within car parking areas.

C4.11 Development plots ground profile shall be tied into the existing landform along their edge at a gradient not exceeding 1:3. Where possible to help screen service yards and built form, the ground between plot and infrastructure corridors shall be profiled to a 1:3 bund (see Figures 9A-9C, 10A and 10B).

C4.12 The soft landscaping scheme for each plot shall be implemented in full accordance with the details submitted with the Prior Notification within the first full growing season after building completion or occupation whichever is the sooner. Where the landscape implementation is deferred until the first available planting season, the topsoiling works shall be maintained to eradicate weed establishment. New landscaping shall be maintained and remedial action taken as necessary for five years after planting. Maintenance thereafter shall continue in accordance with the Landscape Management Plan (Appendix 2). Cutting of the mosaic of short turf, bare ground and flowery swards in the areas shown on Figure 8 shall be varied across the site and different parts of the mosaic shall be cut annually.

C4.13 The soft landscaping scheme for plots, except for the western and southern boundaries of the area shown on Figure 8 shall comply with the detailed soft landscaping specification set out at Appendix 1.

C4.14 Plant species in general will include (but will not be restricted to) those listed within Appendix 1 except for the western and southern boundaries of the area as shown on Figure 8. Paragraph C4.6 and C4.7 details the plant species that shall be planted along the western and southern boundaries of this area.

## **C5 Landscape Management Plan**

C5.1 A coherent, strategic and integrated approach to the management and maintenance of the soft landscape components associated with the development, shall be adopted in accordance with the Landscape Management Plan set out at Appendix 2 to ensure the successful establishment of vegetation and overall integration within the surrounding landscape.

## **C6 External Finishes**

C6.1 External finishes shall generally be a selection of concrete, tarmacadam or block paviors / paving slabs with road marking and parking demarcated in white/ yellow thermoplastic paint or via distinctively different coloured blocks. Areas over sewage treatment systems shall be dressed with 75mm depth of gravel over geotextile membrane with timber edgings. Areas of soft landscaping within the development plots shall be designed with kerb protection to prevent damage caused by vehicles, with a gravel offset of 600mm adjacent to car parks (as shown on figures 9A, 9D and 10A), and 1500mm adjacent to service years/HVG parking areas (as shown on figures 9B, 9C and 10B) to ensure no overrun of landscaping.

## **C7 Earth Shaping and Planting Regime**

C7.1 Individual plots shall include earth shaping elements particularly at their perimeter in order to accommodate drainage wetland areas if required as part of the drainage system and sculptural landform and mounding to enhance enclosure and provide additional interest. To enable safe access for planting / maintenance, slopes shall not exceed a gradient of 1:2 where planted with ornamental shrub species and 1:3 in all other locations.

C7.2 On plot water bodies shall generally be located away from key pedestrian routes unless edge protection is provided in accordance with Paragraph C7.7.

C7.3 The landscape composition of the plot water bodies shall include loose rock base with a combination of planting treatments including blocks of trees, shrubs, aquatic planting and managed flowering grass sward to the upper slopes.



C7.4 Species selection for marginal plants shall be robust and able to cope with changes in water level. Over time there shall be a subtle adaptation in the planting scheme in response to fluctuations in water level and management techniques.

C7.5 Where stepped access is provided to water bodies, slopes shall not exceed a maximum gradient of 1:3 to allow for emergency egress from the water. Elsewhere, water bodies shall be designed to accommodate areas where the maximum gradient does not exceed a slope of 1:5.

C7.6 The soft landscaping scheme for plots shall comply with the detailed soft landscaping specification set out at Appendix 1.

### *Safety*

C7.7 Landscaping shall be utilised as a safety barrier to discourage public access to the ponds. Timber knee rails shall be installed as a guide to pedestrians where planting is not otherwise present.

## **D External Areas**

### **D1 External Storage**

D1.1. External storage shall be provided in service yards to the rear of the building and shall not front onto the primary or secondary infrastructure corridor where possible. Where plots do not benefit from a rear service yard, or if it is not possible to locate the external storage to the rear of the building, external storage fronting the primary infrastructure corridor shall be situated behind a 10m wide landscaped zone and, where fronting a secondary infrastructure corridor, behind a 5m wide landscape zone.

D1.2 Other than in the 'External Storage Exception Zones' shown on Figure 14, external storage shall have a maximum plot coverage of 2% or 2,000 sq.m whichever is the lesser and shall not exceed 6m in height and shall be within fenced areas not exceeding 3m in height.

D1.3. External storage within the 'Southern External Storage Exception Zone' shall have a maximum plot coverage of 20% or 15,500 sq.m whichever is the lesser and shall not exceed 6m in height and shall be within fenced areas not exceeding 3m in height.

D1.4 External storage within the 'Northern External Storage Exception Zone' shall have a maximum plot coverage of 25% or 7,500 sq.m whichever is the lesser and shall not exceed 3m in height and shall be within fenced areas not exceeding 3m in height.

### **D2 Ancillary Infrastructure**

D2.1 Ancillary infrastructure including permanent plant and equipment shall be appropriately sited and limited in noise output in accordance with Paragraph A7.4. Such plant and equipment may include (but need not be limited to) external:

- chiller plants;
- sprinkler tanks and pumphouses;
- pneumatics;
- aerosol stores;

Figure 14: External Storage Areas

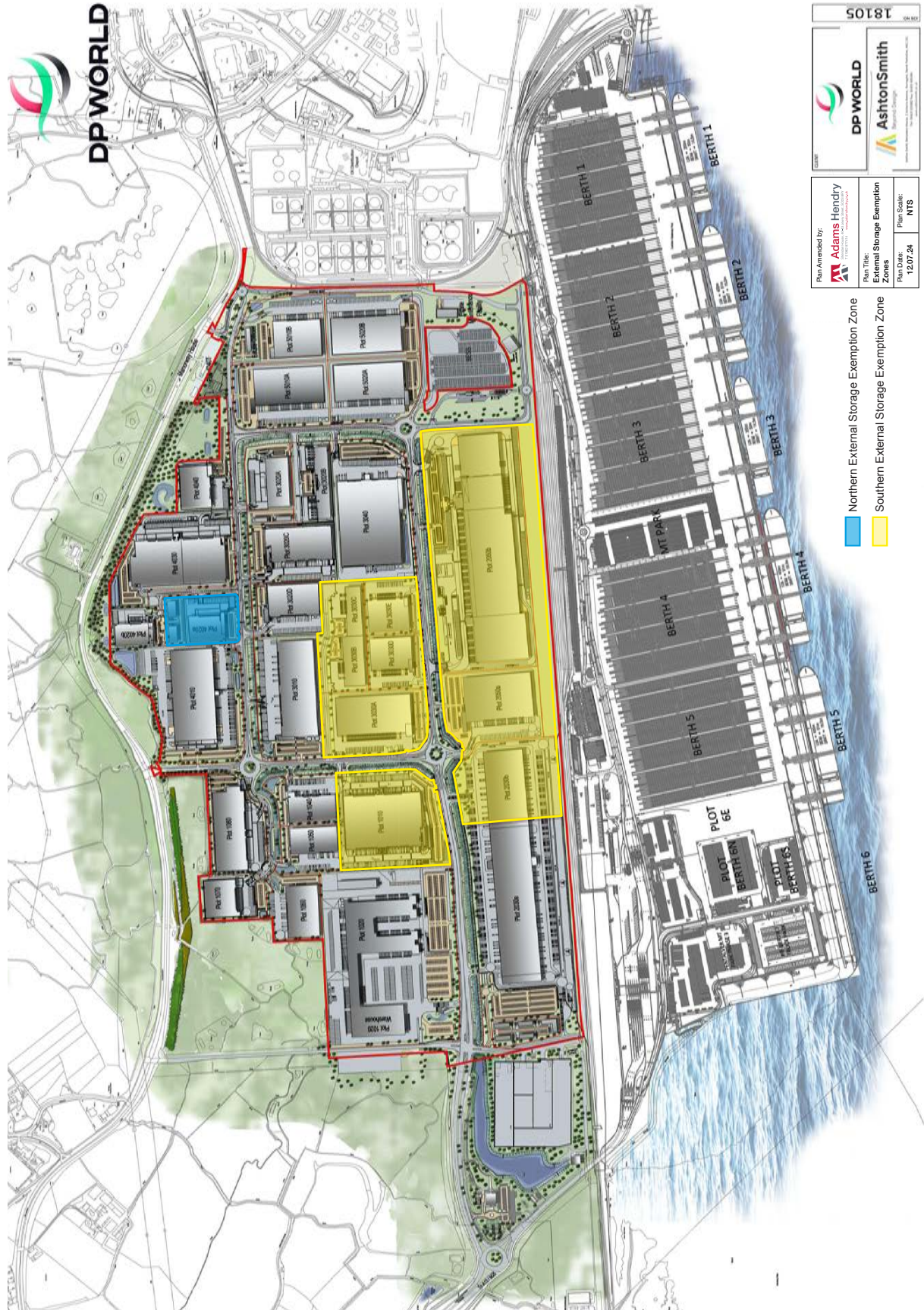

- compressor housing;
- generators;
- generator switchgear enclosures;
- electricity sub stations and ancillary electrical system stations;
- refuse areas; and
- air conditioning units.

D2.2 Electricity sub stations and ancillary electrical system stations may also be located on the plot boundary provided they are appropriately landscaped ensuring access and ventilation requirements can be met at all times.

D2.3 The height of ancillary infrastructure shall not exceed the eaves of the associated building.

## E On-Plot Drainage Standards

### E0 Overview

E0.1 An overview of the drainage strategy is depicted in the schematic shown in Figure 15.

**Figure 15: Foul and surface water drainage schematic**

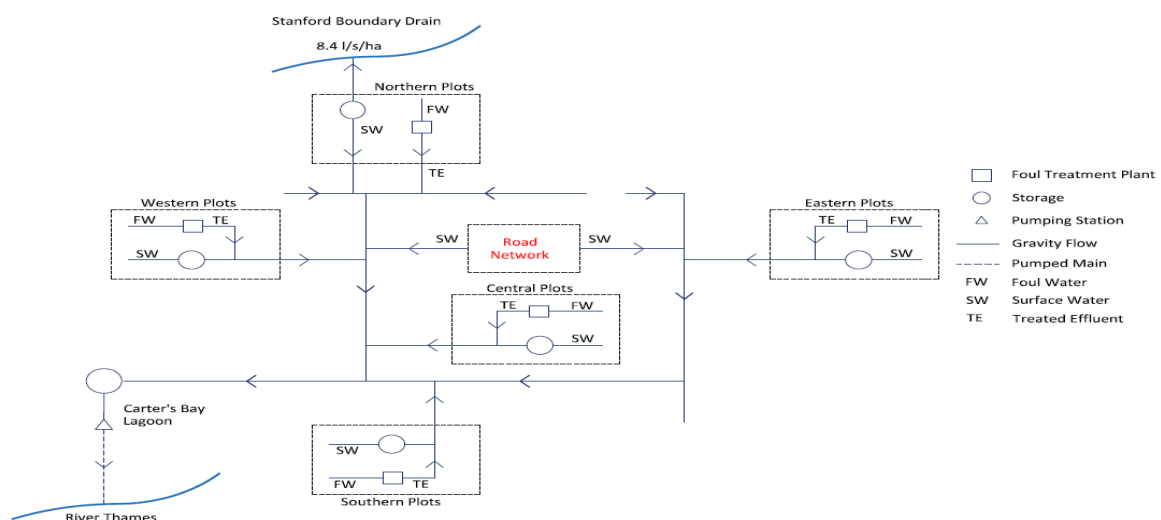

### E1 Foul Water Drainage and Treatment

E1.1 Foul water shall be treated on-plot and discharged to the Park swale system or on-plot to a soakaway. All treatment plant installations will require an Environmental Permit under the prevailing Environmental Permitting Regulations.

E1.2 A modular submerged aerated filter (SAF) package treatment plant shall be procured and installed in each plot unless other treatment technologies prove to be more effective for the plot.

E1.3 Smaller plots may share a treatment plant. Operation and maintenance shall be in accordance with supplier's instructions and the British Water Maintenance and Service Code of Practice.



E1.4 The size of the on-plot treatment plant will vary depending on the hydraulic and biological load. For preliminary design purposes it can be assumed that an area of approximately 20m x 10m will be required for the plant and associated control panel.

E1.5 The plants shall be sized based on the maximum number of people anticipated to be working within the plot. The flows and loads shall be calculated according to the methodology laid out in the latest edition of British Water's 'Code of Practice – Flows & Loads – Sizing Criteria, Treatment Capacity for Small Wastewater Treatment Systems. Where a canteen is to be provided, the appropriate loads shall be used in the design. A grease treatment or removal (trap or bacterial dosing system) shall be provided to prevent grease reaching the plants.

E1.6 The plants shall include primary settlement, biological treatment and humus tanks, and ancillary equipment such as blowers and pipework as required for the operation of the plants. Duty/standby blowers shall be provided.

E1.7 The treatment plants shall be provided with an alarm system linked to the on-plot control centre. An alarm will be generated if the air pressure in the air supply is low, the blowers have failed or the power supply to the plant has failed. It will also indicate pump or power failure and high water level in the sump.

E1.8 If a reedbed is installed as part of the treatment process, it shall be designed and constructed in accordance with Building Regulations and planted with phragmites australis or similar.

E1.9 Occupiers will be the Environmental Permit holder and shall be responsible for the design, construction and maintenance of the treatment plant. London Gateway Services Limited (LGSL) will act as the management company to manage the Park and will have the right to monitor plant performance at any time and will have emergency access rights to undertake remedial action should it be necessary. It shall manage the swales, including routine water quality monitoring and shall respond to environmental incidents.

E1.10 Monitoring shall be undertaken on a quarterly basis or other time period as agreed with the Environmental Advisory Group (EAG). The monitoring results shall be made available to the EAG on request.

E1.11 The following measures shall be complied with during the design and installation of the foul drainage treatment and pumping installations:

- i. Equipment control panels shall be located in readily accessible locations with very low flood risk potential.
- ii. Alarm systems shall be provided to ensure rapid response to any potential major pollution risk to the primary surface water drainage system.
- iii. Vehicular access shall be provided to meet the operation and maintenance requirements of the selected treatment and pumping facilities.
- iv. Wet well venting shall be implemented in accordance with the Dangerous Substances and Explosive Atmosphere Regulations (DSEAR). These regulations will identify potentially hazardous zones that will in turn impact on the location of pumping stations and vent columns in proximity to buildings.
- v. A sampling chamber, the design of which shall be agreed with the Environment Agency, shall be provided downstream of each treatment plant and any tertiary treatment that is provided to allow sampling and flow measurement of the final effluent.
- vi. The risk of pollution from mechanical/electrical/process failure shall be evaluated to inform the choice of installation design solutions.



E1.12 Analysis has shown that where dilution of treated effluent with base flows in the swale system to a ratio of 8:1 can be achieved, the treated effluent quality discharged into the swales should be at least SS 30 mg/l; BOD 20 mg/l and NH<sub>3</sub>-N 20mg/l.

E1.13 The EA will set effluent quality conditions as part of the Environmental Permit for each installation. The effluent quality required for each treatment plant will be decided on a case by case basis and the level of treatment necessary determined accordingly.

E1.14 A sampling chamber agreed with the Environment Agency, shall be installed downstream of the treatment process to allow sampling and testing of the final effluent prior to discharge to the watercourse. The sampling point shall be identified by signage.

E1.15 The treated effluent may be drained to an on-plot lagoon containing reeds, which could form part of the treatment process. The final effluent compliance monitoring point shall be located after all the treatment processes. Some treated effluent may soak away through the base of the lagoon. This may require a permit from the Environment Agency under the Groundwater Regulations 2010. Based on the results of a percolation test, the unlined on-plot lagoon could have an appropriate area to allow some of the effluent from the treatment plant to drain away into the ground. However, this percolation should not be relied upon as part of the means of effluent disposal.

E1.16 Where possible, flow to the lagoon shall be by gravity. Wherever pumping is required a pumping arrangement with duty/standby submersible pumps shall be installed.

E1.17 The foul water drainage networks for the plots shall be designed in line with Building Regulations Approved Document H, BS EN 752, Civil Engineering Specification for the Water Industry (CESWI) 7th Edition and Sewers for Adoption 7th Edition (or latest equivalent guidance) as applicable to pass flows based on the proposed occupancy of the site and the likely water demand.

E1.18 Pollution Prevention Guidelines “Treatment and Disposal of Foul Sewage where no Foul Sewer is Available” (PPG4), or the latest equivalent guidance, shall be used as a guide for the treatment and disposal of sewage. Whilst the PPG previously maintained by the EA has been withdrawn, it remains available on the Government’s national archives and is still considered a relevant source of good practice guidance.

## **E2 Surface Water Drainage**

E2.1 The surface water drainage for the plots shall be designed in line with Building Regulations Approved Document H, BS EN752, Design and Construction Guidance for foul and surface water sewers offered for adoption under the Code for adoption agreements for water and sewerage companies operating wholly or mainly in England (Version 2.1, May 2021), C635: Designing for exceedance in urban drainage, (or latest equivalent guidance) and best practice guidance to pass the 1 in 2 year flow without surcharge in the system. Where one document is updated in advance of the others that updated document shall prevail where there is any conflict with the other documents.

E2.2 Sustainable methods of surface water collection, conveyance, disposal and attenuation shall be preferred over traditional methods and shall be implemented on each plot wherever practicable to CIRIA 753: The SuDS Manual and CIRIA 768: Guidance on the construction of SuDS (or latest equivalent guidance) to withstand flooding up to the 1 in 30 year return period.

E2.3 Flooding for flows up to 1 in 100 year return period + 25% allowance for climate change (or latest equivalent climate change guidance) may be contained within low-risk areas such as car parks and landscaped areas within the plot boundaries of both Southern and Northern Zones as shown on Figure 16 and may be pumped or overflow to the Logistic Park swale provided that the design avoids flooding of internal property in this event.

E2.4 Surface water runoff from the plots in the Southern Zone shall be discharged to the Park swale either by gravity at an unlimited rate or pumped at a maximum rate of 90 litres per second per hectare.

E2.5 Surface water runoff from the Northern Zone plots (as shown on Figure 16) shall be pumped into on-plot balancing storage facilities which will then outfall at controlled discharge rate into the adjacent Stanford Boundary Drain (SBD). If the maximum discharge rate is reached then it will also discharge into the Park swale either by gravity at an unlimited rate or pumped at a maximum rate of 90 litres per second per hectare.

E2.6 The allowable discharge to SBD shall be limited to the equivalent Greenfield runoff rate as calculated in accordance the Institute of Hydrology Report No. 124, i.e. QBAR = 2.6l/s/ha; 1 in 30 year return period = 6.0l/s/ha; 1 in 100 year return period = 8.4l/s/ha.

E2.7 Occupiers shall undertake their own risk assessment of their plot, given the nature of their business, and provide back-up pumps and power if necessary.

E2.8 Plans of the surface water drainage infrastructure shall be submitted to the Lead Local Flood Authority (LLFA) for information no later than the submission date of a prior notification request.

**Table 7: Summary of Design Parameters**

Item	Parameter	Nominal
Allowable Discharge	To Northern Plots to Stanford Boundary Drain	8.4 l/s/ha
	From Southern Plots to the Swale – by gravity	Unlimited
	From Southern Plots to the Swale – by pumping	90 l/s/ha
Design Standard	On-Plot drainage system	1 in 30 year without flooding  1 in 100 year + 25% Climate Change with flooding routed to safe areas such as car parks or pumped or overflow to the swale (from both Southern and Northern Plots).
	Final effluent consent	To be determined through environmental permit.

Figure 16: Drainage catchment zones

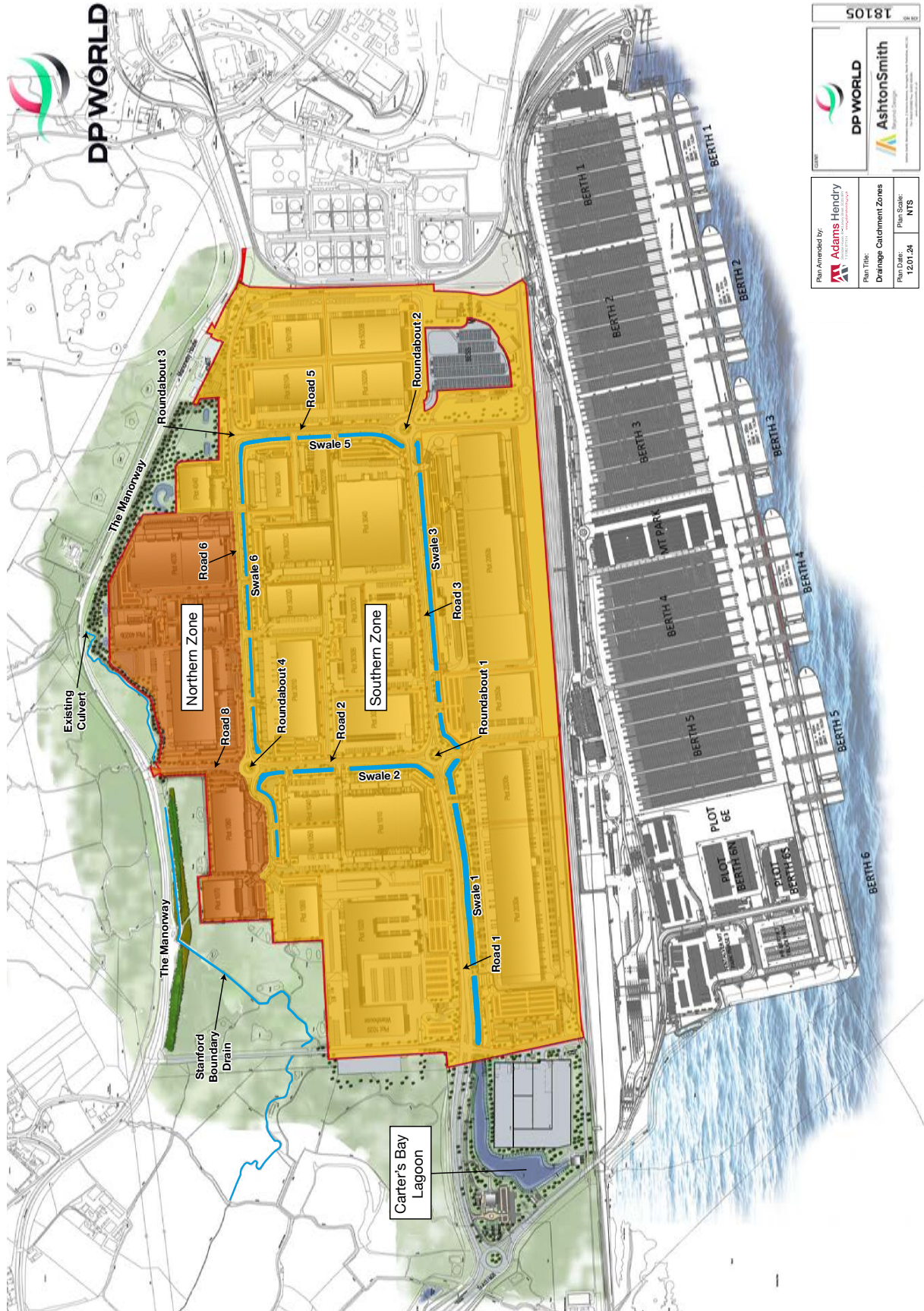

18105	
 <b>DP WORLD</b>	 <b>AshtonSmith</b> Research & Design
Plan Amended by:  <b>Adams Hendry</b>	Plan Title: <b>Drainage Catchment Zones</b>
Plan Date: 12.01.24	Plan Scale: NTS



### E3 Pollution Control

E3.1 A Pollution Prevention Plan shall be prepared for each plot by the occupier. It shall have regard to the processes and risks associated with the proposed business activities and this shall be made available for inspection at any time. Provision shall be made as part of the PPP to minimise the risk of remobilisation of, and washout of any pollutants such as sediment. Equipment to contain spillages, including oil booms but also drain blockers and dams to contain soluble pollutants, shall be made readily available.

E3.2 The swales alongside plot access roads throughout the site shall be inspected, at least on a weekly basis, for signs of pollution, such as oil on the water surface. A programme of monitoring the water quality in the swales and the treatment plant discharges thereto shall be agreed with the Environment Agency prior to occupation of the plots. Where pollution is evident, as with visible oil, appropriate clean-up measures, such as absorbent booms shall be used to remove it. Oil booms shall be removed on completion of the clean-up to avoid re-release of oil or potential blockages.

E3.3 The drainage system from each plot shall require oil separators, grease traps and other containment at source, as necessary for the nature of each business.

E3.4 Any oil, fuel or chemical storage tanks, buildings, ancillary handling facilities, filling, drawing and overflow pipes shall be enclosed within an impervious bunded area of at least 110% of the tank capacity and the bunded area shall be fully constructed in accordance with current Oil Storage Regulations before the relevant part of the development to which it first relates is first occupied or brought into use.

E3.5 Parking areas in excess of 50 spaces, and areas accessed by commercial vehicles or HGV's, shall be drained to the drainage network via an on-site oil separator designed in accordance with Pollution Prevention Guidelines 'Use and Design of Oil Separators' (PPG3). Silt shall be managed at source. Whilst the PPG previously maintained by the EA has been withdrawn, it remains available on the Government's national archives and is still considered a relevant source of good practice guidance.

E3.6 In the event of a major pollution incident occurring on-plot, the system shall be isolated or discharge to the swale shall be shut down until the pollution incident has been cleaned up.

E3.7 Plot drainage shall be separated from the main surface water drainage system at the following locations to allow for the containment of pollutants:

- Loading areas where spillage of cargo may occur;
- Skip/waste storage areas;
- Areas where chemicals and oils are stored;
- Boiler/chiller areas where condensates are discharged.

E3.8 In areas where there is a high risk of spills, penstocks should be installed in the drainage, to limit the risk of pollution to the main surface water drainage system.

E3.9 Surface water runoff from waste storage areas and any other high risk areas shall be treated appropriately and discharged in accordance with relevant Building Regulations, PPG and SUDS guidance.



# **Part 2: Plot Design Standards for Offices, Food and Drink, Shop, Gym, Creche/Day Nursery and Outdoor Sports Facilities**

## **Part 2: Plot Design Standards for Offices, Food and Drink, Shop, Gym, Creche/Day Nursery and Outdoor Sports Facilities**

### **F Plot and Building Design Standards**

#### **F1 Plots**

F1.1 For the purposes of this Design Code, amenity uses include shops, gyms, food and drink outlets, a creche/day nursery and outdoor sports facilities. An amenity hub comprises at least three of these uses within a mixed-use building.

F1.2 Amenity uses shall be located together, ideally as part of a mixed-use building, close to the main access to the Logistics Park or within a central part of the site.

F1.3 The ground floor shall be designed with the potential to accommodate a creche/day nursery, a shop and/or a food and drink outlet and should allow maximum flexibility for fitout and future change of use.

F1.4 The principal elevation (normally containing the main public entrance to the building and including windows on the ground floor) shall front onto a primary or secondary access road or external public space to create interest and activity (an active frontage). Where a building occupies a corner plot, an active frontage shall be maintained on both frontages.

F1.5 Amenity uses will not be permitted within the Health and Safety Executive (HSE) Consultation Zone or 'Envelope of Safeguarding Distances SD3' as shown on Figure 2.

F1.6 Offices shall not be located within the HSE middle zone, outer zone or 'Envelope of Safeguarding Distances SD3' as shown on Figure 2.

F1.7 Offices may be located within the HSE Inner Zone (IZ) where:

- the number of occupants in each building is less than 100 and the building has less than 3 occupied storeys.
- the area within the IZ will be used for parking serving the plot.

#### **F2 Building Size**

F2.1 The maximum gross internal floorspace of any single retail unit within (Use Class F(2)(a) (shops) shall not exceed 280sq.m

F2.2 'Gross Internal Floorspace' is equivalent to 'Gross Internal Area' as calculated in accordance with the RICS Code of Measuring Practice (sixth edition) or any revision thereto.

F2.3 Buildings shall maintain a minimum separation distance of at least 8m to the plot boundary.

#### **F3 Height**

F3.1 Buildings shall be designed to make the most efficient use of the site with the potential to be at least three storeys high either on construction or in the future.

F3.2 Development shall not exceed the maximum height for the zone/plot in which the building is to be located as shown on the Height Zoning Plan (Figure 4).

## **F4 Building Materials and Roofing Principles**

F4.1 A palette of different materials shall be used in order to achieve articulation and texture in the overall appearance of the area.

F4.2 The visual impact of the colours and finishes of wall and roof cladding materials shall be considered in relation to the background and the context of the building. All buildings shall maximise natural light, passive heating, cooling and ventilation. This can be achieved through using stack effect, cross ventilation, rooflights, double-skin facades, and other strategies for passive environmental regulation.

F4.3 Where glass curtain walling is proposed, vertical brise-soleil shall be incorporated on east-west building elevations and horizontal brise-soleil to south building elevations.

F4.4 Architectural features shall demarcate the main public entrance to buildings. This can include articulation of the façade using a change in volume, canopy, floor or paving finish, signage, and contrasting changes in material treatment.

F4.5 Any extension or alteration to a building shall have a similar external appearance to the existing building.

F4.6 Any ancillary building shall meet the same architectural standards as the main building.

F4.7 Buildings shall be constructed from the following palette of materials:

- Glass curtain walling/ storey height glazed panels.
- Aluminium/stainless steel mesh.
- Polycarbonate panels.
- Exposed concrete.
- Natural timber cladding (synthetic boarding is not acceptable).
- Brick (not buff, light or white in appearance).
- Corten Steel cladding.
- Anodised aluminium curtain walling.
- Aluminium ribbon windows.
- Brass/copper products.

F4.8 Roofs shall be constructed from the following palette of materials:

- Galvanised steel profiled sheet/corrugated galvanised steel.
- Anodised aluminium.
- Slate.
- Biodiverse/green roofing.

## **F5 Roofscape and Plant**

F5.1 Roof mounted plant excluding roof mounted PV, flues and vents shall require screening behind a parapet wall, or integration within the building to maintain clean horizontal roofscapes.

## **F6 Fixed Plant**

F6.1 Fixed plant such as chiller units on noise sensitive elements shall comply with the appropriate British Standard for these noise sensitive spaces, including BS8233:2014.

F6.2 Chiller units and any other ventilation ducts should be limited to less than 85 dB(A) at 1 metre.

## **F7 Ventilation and Extraction for Premises serving Hot Food**

F7.1 Where hot food is proposed to be served, ventilation and extraction systems shall ensure that no nuisance, disturbance or loss of amenity is caused by odour or smoke/fumes, food droplets to occupants of nearby premises.

F7.2 The design of ventilation and extraction systems shall be undertaken by a suitably qualified person. Details shall be submitted for approval by the local authority Environmental Protection Officer (EPO) (in consultation with the Public Protection Department) in advance of the LDO2 prior notification process in the form of a Ventilation and Extraction Design Statement (VEDS).

F7.3 The EPO shall have no more than 20 working days to consider the VEDS unless an extension of time is agreed in writing with the applicant and the local planning authority. To enable the EPO to assess the suitability of a ventilation scheme, the following information shall be provided:

- Information on premises including the number of meals to be served per day; the method(s) of preparation and cooking; and proposed hours of operation of the business and any ventilation plant.
- A scaled plan showing the internal arrangement of the premises and the dimensions/location of the ventilation system. The plan must contain external elevations of the buildings showing the dimensions, route; and exhaust termination characteristics (i.e. appearance) of the ductwork in relation to the building. The location of all filters and the fan must be clearly marked. Where the location of a filter is shown the type must be clearly identified and cross-referenced to the detailed product specification.
- Where an odour counteractant or neutralising system is proposed the details and type should be identified.
  - Cooker hood characteristics – dimensions, dwell time of the gases in the carbon filtration zone, efflux velocity.
  - System Operation - extract rate, dwell time of the gases in the carbon filtration zone, efflux velocity.
  - Flue Design: the height and velocity of the final discharge stack.
  - Maintenance schedule for all systems.
- Where the hot food outlet is part of a mixed-use building, details of other uses within that building.

F7.4 The kitchen extract system shall be installed in full accordance with the VEDS and permanently maintained thereafter. No changes to the installed system shall be made without prior approval.

F7.5 The food outlet shall register with the Thurrock Council Food Team.

## **F8 External Building and Site Signage**

F8.1 All signage and advertisements on the site shall be subject to the Town and Country Planning (Control of Advertisements) (England) Regulations 2007 as amended.



**F9 Sustainable Design Standards**

F9.1 The standards set out in Part 1 Section A10 will apply.

**F10 Creche/ Day Nursery (Use Class E(f))**

F10.1 The design of buildings for use as a creche and/or day nursery shall accord with the 'Early Years Foundation Stage Statutory Framework for group and school-based providers' published by the Department for Education in December 2023 or as subsequently amended.

F10.2 Outdoor space shall be designed to be used all year round. A covered canopy or veranda shall provide a transitional space linking indoor playrooms and outdoor spaces which shall be deep enough to provide shade and shelter from the sun, wind and rain without reducing the level of light in adjacent rooms.

F10.3 The outdoor area adjacent to the building shall have a hardscape feel with the inclusion of a material such as wetpour surfacing to provide a safe and durable solution for safe play. The rest of the amenity space shall be of a softscape nature which shall be limited to the edge of the boundary treatment. The planting shall follow the current palette see Appendix 1 and follow an evergreen theme with seasonal interest.

F10.4 Any back-filled top-soil shall be play-safe, including play-safe bark or sand. Planting shall not be toxic.

F10.5 If outdoor spaces are not bound by the building, they shall be securely fenced. The boundary fencing shall be a minimum of 2.4m high and shall be solid with no visibility into the outdoor play area from surrounding area. The internal panel of the boundary treatment to be a bespoke designed in with opportunities for playful and colourful features.

F10.6 An outdoor storage area shall be provided and this shall be laid on a hard-concrete surface and be located a corner of the outdoor play space away from children. The storage shall be large enough to hold equipment for the creche and be accessible to the staff.

F10.7 Where wraparound care is to be provided for primary school aged children before and after school (or during school holidays), the levels of internal and external play space shall be agreed with the School Effectiveness Team Manager at Thurrock Council. The School Effectiveness Team Manager shall have no more than 20 working days to consider such a request unless an extension of time is agreed in writing with the applicant and the local planning authority.

F10.8 Paths to the creche/day nursery shall be a minimum of 2m wide, clearly defined, signed and well-lit, with a maximum gradient of 1:20. Cross-falls shall be a maximum of 1:50.

F10.9 Car parking arrangements shall not endanger the safety of the children, visitors, or staff. Car parking shall be set well away from external play space. Where this is not possible, there shall be adequate screening and planting to reduce the effect of vehicle emissions, and to ensure children's safety.

F10.10 There shall be a safe point of access close to the entrance of a day nursery or crèche with enough space to drop off children safely (including those in wheelchairs),

F10.11 Where wrap around care is to be provided as part of a day nursery/creche setting a minibay (8m by 4m) shall be provided to enable children to be dropped off and picked up before and after school.

*Pre-submission consultation requirements*

F10.12 Full design details demonstrating compliance with the 'Early years foundation stage statutory framework for group and school-based providers', shall be submitted for approval by the School Effectiveness Team Manager at Thurrock Council in advance of the LDO2 prior notification process in the form of a Creche/Day Nursey Design Statement (C/DNDS).

F10.13 The School Effectiveness Team Manager shall have no more than 20 working days to consider the C/DNDS unless an extension of time is agreed in writing with the applicant and the local planning authority.

**F11 Outdoor Sports Facilities (Use Class F2 (c))**

F11.1 Artificial Grass Pitches (AGP) suitable for recreational sport shall be located in close proximity to the amenity uses to enable shared use of facilities. The use of rubber crumb as an infill material in the construction of the pitch should be avoided. The AGP shall be enclosed by rigid panel mesh fencing of at least 3m in height and no more than 6m in height with a double gate for maintenance and access.

F11.2 Multi-Use Games Areas (MUGA) e.g. tennis/basketball courts shall be constructed with a porous asphalt/macadam surface with a colour coated non-slip paint finish. Rigid panel mesh fencing of at least 3m in height and no more than 5m in height shall be installed around the perimeter of the court with a double gate for maintenance and access.

F11.3 Any external storage facility required in connection with the use of the outdoor sports facilities shall not exceed 5m length, 2.5m depth and 2.5m height and shall be constructed using composite timber cladding.

F11.4 Any floodlights required for the outdoor sports facilities shall not exceed 10m in height and shall be designed to minimise light spill. Amenity / security lighting should be installed along access routes to help alleviate any severe contrast of lighting conditions when a user comes away from a floodlit facility.

F11.5 The AGP/MUGA should be no closer to trees than a distance equivalent to at least the potential height of the tree and its potential canopy width. Where this is not possible, construction can take place above the tree roots by using 'cellular web' sheeting, which is placed onto the soil, pinned in place and filled with stone ('non-dig' construction).

F11.6 The AWP/MUGA shall be designed to ensure that all surface water is removed from the pitch at a rate which will avoid surface flooding from the facility and surrounding area.

*Pre-submission consultation requirements*

F11.7 A detailed drainage strategy shall be submitted to the Lead Local Flood Authority (LLFA) for approval prior to the Prior Notification process. Confirmation that the drainage strategy has been approved shall accompany any Prior Notification submission. The LLFA shall have no more than 20 working days to consider the drainage strategy unless an extension of time is agreed in writing with the applicant and the local planning authority.

F11.8 The AWP/MUGA shall be constructed and maintained in accordance with the approved drainage strategy.

## **G Roads, Parking and Access**

### **G1 Plot Access**

G1.1 The design of access roads into individual development plots shall comply with the standards for access visibility set out in the Design Manual for Roads and Bridges (DMRB).

G1.2 Where practical or viable, pedestrian, cycle and car access to individual units from the internal site highway network shall be designed to provide separation from goods vehicles for safety and security purposes and to prevent queuing of vehicles on the estate roads.

G1.3 To meet health, safety and security requirements on development plots, footpaths and cycleways shall be terminated at the plot threshold and internal plot layouts shall be designed to accommodate individual occupier requirements whilst maintaining safe routes to the buildings for pedestrians.

G1.4 Fences or gates shall not obscure sight lines of any junction on the estate roads or any vehicular access to the highway.

G1.5 Where practical or viable, plot access onto the road to the amenity hub will be at least 90m from the access to any adjoining plot when on the same side of the road.

### **G2 Plot / Amenity Hub Based Vehicle Servicing**

G2.1 Provision shall be made for the loading, unloading and turning of commercial vehicles to meet normal servicing requirements. Vehicle tracking details of the largest vehicle likely to be required shall be submitted with any prior notification submission. Vehicular access to external areas shall accommodate maintenance vehicles and fire and rescue service vehicles in accordance with building control regulations.

G2.2 There shall be a clearly demarked safe pedestrian walkway between individual buildings and outdoor sport facilities. Pedestrian routes shall include tactile surfacing and shall be separate from car access, commercial delivery and servicing routes.

G2.3 Parking and vehicle circulation shall be designed to allow free flowing access to all external areas of the building required by the unit operator. Full site circulation shall be maintained in compliance with Building Regulation requirements.

### **G3 Parking Standards**

G3.1 The amenity hub or individual unit shall be designed to achieve optimum vehicle parking requirements to prevent vehicles queuing on the highway.

G3.2 Car parking shall be provided in accordance with the maximum standards specified in Tables 8 - 15 below and shall be made available for use during the time that any part of a building is open to any persons employed within the building or to persons visiting the building. Standards for electric vehicles, cycle, blue badge holders and motorcycles are minimum standards.

G3.3 These parking standards in this document will apply until such time as they are updated by Thurrock Council in which case the updated standards would apply.

G3.4 Dedicated and conveniently located parking spaces with charging points and facilities for the charging of electric vehicles shall be provided.

G3.5 Charging points shall be activated in line with occupier demand having regard to the use of car parking spaces dedicated for electric vehicle parking which is to be surveyed and reported in the annual survey in line with the LDO2 Travel Plan.

G3.6 Where a development incorporates two or more land uses to which different parking standards are applicable, the standard appropriate to each use shall be applied in proportion to the extent of the respective use.

G3.7 The width of standard parking bays with end bays adjacent to solid structures shall be increased by 1m to allow for manoeuvrability on entry/exit to and from the vehicle. Clear directional marking signs shall be set out using suitable signs and surface arrows.

**Table 8 - Parking Standards for Offices - Use class E(g)(i)**

Car	Electric car charging points	Cycle	Blue Badge	Motorcycle
1 space per 30 sq.m	50 spaces or fewer = 1 space with charging point  Over 50 spaces = 2% of total spaces with charging points  Passive provision for all remaining spaces	1 space per 100 sq.m for staff plus 1 space per 200 sq.m for visitors.  Passive provision for e-bike charging for all spaces regardless of total number.	200 vehicle spaces or less = 2 spaces or 5% of total capacity (whichever is greater)  Over 200 car spaces = 6 spaces plus 2% of total capacity	1 space + 1 per 20 car spaces (for first 100 car spaces); then  1 space per 30 car spaces (over 100 car spaces)  Passive provision for e-motorcycle charging for all spaces regardless of total number.

**Table 9 - Parking Standards for sale of food and drink for consumption (mostly) on the premises - Use Class E(b)**

Car	Electric car charging points	Cycle	Blue Badge	Motorcycle
1 space per 5 sq.m	550 spaces or fewer = 1 space with charging point  Over 50 spaces - 2% of total spaces with charging points  Passive provision for all remaining spaces regardless of total number	1 space per 100sq.m for staff plus 1 space per 200sq.m for customers  Passive provision for e-bike charging for all spaces regardless of total number.	200 vehicle spaces or less = 3 spaces or 6% of total (whichever is greater)  Over 200 vehicle spaces = 4 spaces plus 4% of total	1 space + 1 per 20 car spaces (for first 100 car spaces); then  1 space per 30 car spaces (over 100 car spaces)  Passive provision for e-motorcycle charging for all spaces regardless of total number.



**Table 10 - Parking Standards for indoor sport, recreation or fitness Use Class E(d)**

<b>Car</b>	<b>Electric car charging points</b>	<b>Cycle</b>	<b>Blue Badge</b>	<b>Motorcycle</b>
1 space per 10 sq.m	50 spaces or fewer = 1 space with charging point  Over 50 spaces = additional 2% of total spaces with charging point  Passive provision for all remaining spaces	10 spaces plus 1 space per 10 car spaces  Passive provision for e-bike charging for all spaces regardless of total number.	200 vehicle spaces or less = 3 spaces of 6% of total (whichever is greater)  Over 200 vehicle spaces = 4 spaces plus 4% of total capacity	1 space + 1 per 20 car spaces (for first 100 car spaces); then  1 space per 30 car spaces (over 100 car spaces)  Passive provision for e-motorcycle charging for all spaces regardless of total number.

**Table 11 - Parking Standards for creche, day nursery or day centre - Use Class E(f)**

<b>Car</b>	<b>Electric car charging points</b>	<b>Cycle</b>	<b>Blue Badge</b>	<b>Motorcycle</b>
1 space per full time equivalent staff plus pick up/drop off facilities	50 spaces or fewer = 1 space with charging point  Over 50 spaces = additional 2% of total spaces with charging points  Passive provision for all remaining spaces	1 space per 4 staff plus 1 space per 10 child spaces  Passive provision for e-bike charging for all spaces regardless of total number.	1 space or 5% of total car spaces, whichever is the greater	1 space + 1 per 20 car spaces (for first 100 car spaces); then  1 space per 30 car spaces (over 100 car spaces)  Passive provision for e-motorcycle charging for all spaces regardless of total number.

**Table 12 - Parking Standards for shops selling essential goods - Use Class F2(a)**

<b>Car</b>	<b>Electric car charging points</b>	<b>Cycle</b>	<b>Blue Badge</b>	<b>Motorcycle</b>
1 space per 20 sq.m for non food; or  1 space per 14 sq.m for food stores	50 spaces or fewer = 1 space with charging point  Over 50 spaces = additional 2% of total spaces with charging points  Passive provision for all remaining spaces	1 space per 400 sq.m for staff. 1 space per 400 sq.m for customers.  Passive provision for e-bike charging for all spaces regardless of total number.	200 vehicle spaces or less = 3 spaces of 6% total capacity, whichever is greater. Over 200 vehicle spaces = 4 spaces plus 4% total capacity.	1 space with passive provision for e-motorcycle charging

**Table 13 - Parking Standards for outdoor sport or recreation - Use Class F2(c)**

Car	Electric car charging points	Cycle	Blue Badge	Motorcycle
20 spaces per pitch plus 1 space per 10 spectator seats.	50 spaces or fewer = 1 space with charging point  Over 50 vehicle spaces = 2% of total spaces charging points  Passive provision for all remaining spaces	10 spaces plus 1 space per 10 vehicle spaces.  Passive provision for e-bike charging for all spaces regardless of total number.	200 vehicle spaces or less = 3 spaces or 6% of total capacity, whichever is greater.  Over 200 vehicle spaces = 4 spaces plus 4% of total capacity	1 space + 1 per 20 car spaces (for 1st 100 car spaces), then 1 space per 30 car spaces.  Passive provision for e-motorcycle charging for all spaces regardless of total number.

G3.8 The parking standards for outdoor sport or recreation (F2 (c)) shall apply unless otherwise agreed with the Highway Authority in writing in advance of the LDO2 prior notification process.

G3.9 In addition to providing parking for disabled drivers as described in the code of practice BS8300:2009 (including amendments), a parking priority scheme for car sharers shall be implemented in line with the requirements of the LDO2 Travel Plan. Space for people with disabilities shall be located adjacent to entrances and shall be marked with lines and the International Symbol for Access.

**Table 14: Car Parking Dimensions**

Type	Dimensions
Standard	2.5m x 5.5m
Blue Badge	3.9m x 6.5m

G3.10 Lorry parking bay dimensions shall be in accordance with the standards set out in Part 1, Section B4, Table 5.

G3.11 There shall be no parking on estate roads.

## **G4 Cycle Parking**

G4.1 The standards set out in Part 1 Section B5 will apply.

## **G5 Materials for Road Construction**

G5.1 The standards set out in Part 1 Section B6 will apply.

## **G6 Standards for Footpaths and Cycleways**

G6.1 The standards set out in Part 1 Section B7 will apply.

# **H Lighting**

## **General Considerations**

H1.1 The standards set out in Part 1 at paragraph B8.1 – B8.10 shall apply.

## Lighting for Car Parks

H1.2 Lighting shall be in accordance with the principles and guidance detailed Table 5.9 in BS EN 12464-2:2014.

### *Performance Requirements*

H1.3 The lighting designer shall assess whether the proposed use is likely to generate light or medium traffic. Where light traffic is likely, such as for a shop, the average illuminance shall be 5 lux with a uniformity of 0.25. Where medium traffic is likely such as for an office or multipurpose building the average illuminance shall be 10 lux with a uniformity of 0.25

### *Lighting Arrangement*

H1.4 The car park area shall use the Thorlux Starbeam luminaire (or equivalent) with a lumens output and distribution to suit the development and to ensure no over-lighting) at a typical mounting height of 6-8 m with a maximum upward lighting ratio of 2.5% compliant with GN01:21.

H1.5 The typical installation geometry set out in Part 1 at paragraph B8.34 shall apply.

## Lighting for Footpaths

H1.6 Lighting shall be in accordance with the principles and guidance detailed Table 5.1 in BS EN 12464-2:2014.

### *Performance Requirements*

H1.7 For footpath to, from and around buildings or to and from the outdoor sports facilities the average illuminance shall be 5 lux with a uniformity of 0.25 however if this footpath is to be used by slow moving vehicles such as bicycles or commercial vehicles then the average illuminance shall be increased to 10 lux with a uniformity of 0.4.

### *Lighting Arrangement*

H1.8 Where the footpath is beside a building this shall be lit with building mounted downlights with a wider sideways throw for a narrow path using typically the Thorlux Realta with an upward light ratio of not more than 2.5%. If the footpath moves away from a building, the lighting shall be achieved through either wall mounted fittings or circa 5-6m high column mounted footpath fittings as appropriate with an output, light distribution and spacing, optimised to meet the lighting class / performance requirements.

H1.9 The installation geometry set out in Part 1 at paragraph B8.34 shall apply.

## Outdoor Sports Facilities

H1.10 Lighting of outdoor sports facilities shall be in accordance with the principles and guidance outlined in Sport England Design Guidance Note – Artificial Sports Lighting 2012.

### *Performance Requirements*

H1.11 Lighting of outdoor sports facilities shall meet the highest lux / uniformity level of the sport likely to be played on the facility based upon the markings on the pitch/court and shall be

in accordance with Sport England's lighting requirements as per the table below. The maximum illuminance level is 500 lux which can be dimmed as appropriate for the sport being played.

**Table 15: Recommended lighting levels of Outdoor Sports Facilities**

Club and Community lighting for tennis, netball, 5-a-side, basketball, rush hockey				
Club			Community	
	Horizontal Illuminance (Lux)	Uniformity (E <sub>min</sub> / E <sub>ave</sub> )	Horizontal Illuminance (Lux)	Uniformity (E <sub>min</sub> / E <sub>ave</sub> )
Netball	400	0.7	400	0.7
Tennis (recommended)	PPA	500	500	0.7
	TPA	400	400	0.6
5-a-side football	120	0.6	120	0.6
Basketball	200	0.6	75	0.5
Rush hockey	350	0.7	200	0.7

### Lighting Arrangement

H1.12 The lighting for the outdoor sport facilities shall be column mounted floodlights with a maximum height of 10m. The luminaires should have an asymmetric optic and have a maximum tilt of 5 degrees if necessary, ensuring that the upward light ratio when installed does not exceed 2.5%. The arrangement of columns / luminaires should be designed in accordance with guidance from Sport England and best practice to minimise glare to players and spectators.

H1.13 Lighting of the outdoor sports facilities should be switched off when not in use. The footpaths to/from the outdoor sports facilities should be lit as per H1.6 to enable safe pedestrian movement when the outdoor sports facilities lighting is switched off.

### Boundary Security Lighting

H1.14 Boundary security lighting shall be in accordance the standards set out in Part 1 at paragraph B8.38.

## I Landscaping

### I1 Street Furniture

I1.1 Street furniture (e.g. seating, cycle storage etc.) shall be in accordance with requirements set out at Part 3, Section O3 of this document.

### I2 External Amenity Space

I2.1 External amenity space shall be located to minimise noise and pollution from adjacent plots. Amenity space shall be directly accessed from the building and be orientated where possible to maximise daylight and provide shade or covered areas where outdoor seating is proposed. Where appropriate, opportunities for public artwork shall be provided.



### **I3 Boundary Treatment**

I3.1 The requirements for perimeter on-site security and other boundary demarcation as set out in Part 1, section C2 shall apply.

### **I4 Feature Elements**

I4.1 Lighting for landscaped areas for aesthetic effect may be provided. The standards set out Part 1 Section C3 shall apply.

### **I5 Soft Landscaping**

I5.1 The on-plot soft landscaping scheme shall comprise a linear block of tree within the perimeter landscape area frontage onto internal infrastructure roads. The trees shall have a 2m high clear stem. A range of tree species shall be used that have a variety of canopy forms, leaf and bark textures, seasonal colour and growth habits. The size of nursery tree stock shall include a range of native and ornamental species suitable to the site conditions and selected to optimise wildlife benefit and potential for habitat creation. The majority of trees shall be planted as semi-mature.

I5.2 Understorey planting within the frontage perimeter landscaping area shall comprise ornamental shrubs, grasses and groundcover planting.

I5.3 Ornamental shrub, herbaceous and specimen tree planting shall be included within car parking areas and at accent locations such as entrances to buildings or outdoor seating areas, except in seating areas around the outdoor sports facilities. Planting shall provide year round interest. Landscaping shall be designed with trespass, vandalism and other security issues in mind.

I5.4 Planting, if required, around the outdoor sports facilities shall comprise wildflower meadow.

I5.5 The planting schemes shall take into consideration the required visibility for users of internal roads and pedestrians.

I5.6 On each individual plot, a minimum perimeter landscape width of 10m shall be provided adjacent to the infrastructure corridors unless the plot boundary is:

- directly adjacent to a swale on same side of the infrastructure corridor as the plot, where a minimum perimeter landscape width of 7.5m shall be provided; or
- adjacent to an infrastructure corridor with a secondary single access road (as shown on Figure 17) where a minimum landscape width of 5m shall be provided; or
- adjacent to another plot boundary, and provided buildings maintain a minimum separation distance of at least 8m to the respective plot boundaries, the plots shall be separated by shared 2.4m high palisade or paladin security fence with a 1m gravel margin (see Figure 11A and 11B). Surfacing between the fence and the building shall comprise either gravel, concrete, block paving, tarmac or species rich grass sward; or
- adjacent to car parks where landscaping shall include, native understorey trees and a minimum 3.0m wide zone of ornamental planting.

I5.7 There shall be no fencing between the frontage perimeter landscaping strip and the adjacent building and/or car park.

15.8 The soft landscaping scheme for each plot shall be implemented within the first full growing season after building completion or occupation whichever is the sooner. Where the landscape implementation is deferred until the first available planting season, the topsoiling works shall be maintained to eradicate weed establishment. New landscaping shall be maintained and remedial action taken as necessary for five years after planting. Maintenance thereafter shall continue in accordance with the Landscape Management Plan (Appendix 2).

15.9 The soft landscaping scheme for plots shall comply with the detailed soft landscaping specification set out at Appendix 1.

15.10 Plant species will include (but will not necessarily be restricted to) those listed within Appendix 1

## **I6 Landscape Management Plan**

16.1 A coherent, strategic and integrated approach to the management and maintenance of the soft landscape components associated with the development, shall be adopted in accordance with the Landscape Management Plan set out at Appendix 2 to ensure the successful establishment of vegetation and overall integration within the surrounding landscape.

## **I7 External Finishes**

17.1 The standards set out in Part 1 Section C6 shall apply.

## **I8 Earth Shaping and Planting Regime**

18.1 The standards set out in Part 1 Section C7 paragraphs C7.1 – C7.7 shall apply.

## **J Ancillary Infrastructure**

J1.1 Ancillary infrastructure including permanent plant and equipment necessary to support amenities uses and offices shall be in accordance with Part 1 Section D2.

## **K On Plot Drainage Standards**

K1.1 On plot drainage shall be in accordance the standards set out in Part 1 at Section E.

# Part 3: Infrastructure Standards

## Part 3: Infrastructure Standards

### L Highway Design Standards

L1.0 The following highway design standards shall apply to the construction of internal site access roads, footways and cycleways. Road infrastructure connections for each phase of development shall be provided to wearing course prior to operational use of any building.

#### L1 Internal Access Roads

L1.1 The general layout and hierarchy of the internal access roads is shown on Figure 17.

L1.2 Remaining secondary single access roads where a HGV right hand turning lane is required to serve individual plots, and where a swale is to be provided, shall comprise a 11m wide carriageway and be constructed to the dimensional standards identified on the cross sectional drawing set out at Figure 18.

L1.3 Single 7.3m, and 11m wide carriageway roads (incorporating a HGV right hand turn lane), where no swale is required shall be constructed to the dimensional standards identified on the cross-sectional drawings set out at Figure 19 and Figure 20 respectively. The cross fall shall be a 2.5% gradient for a footway/cycleway and 5% for a service strip.

**Figure 18: Single Carriageway Cross Section where a swale is required**

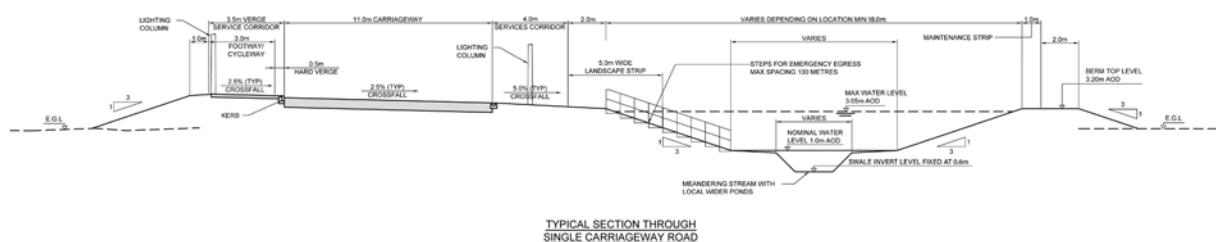

**Figure 19: 7.3m Single Carriageway Cross Section where a swale is not required**

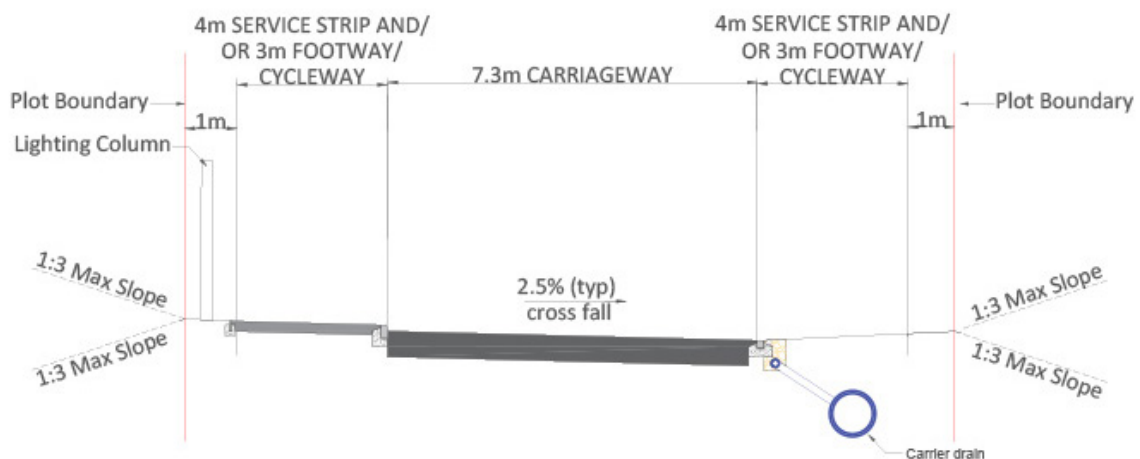

NB: A footway/cycleway shall be provided on at least one side of the carriageway on Roads 3a, 6c and 10 (see paragraph L1.5 and Figure 17) where there shall be a 7.3m wide road.



Figure 17: Layout and hierarchy of internal access roads

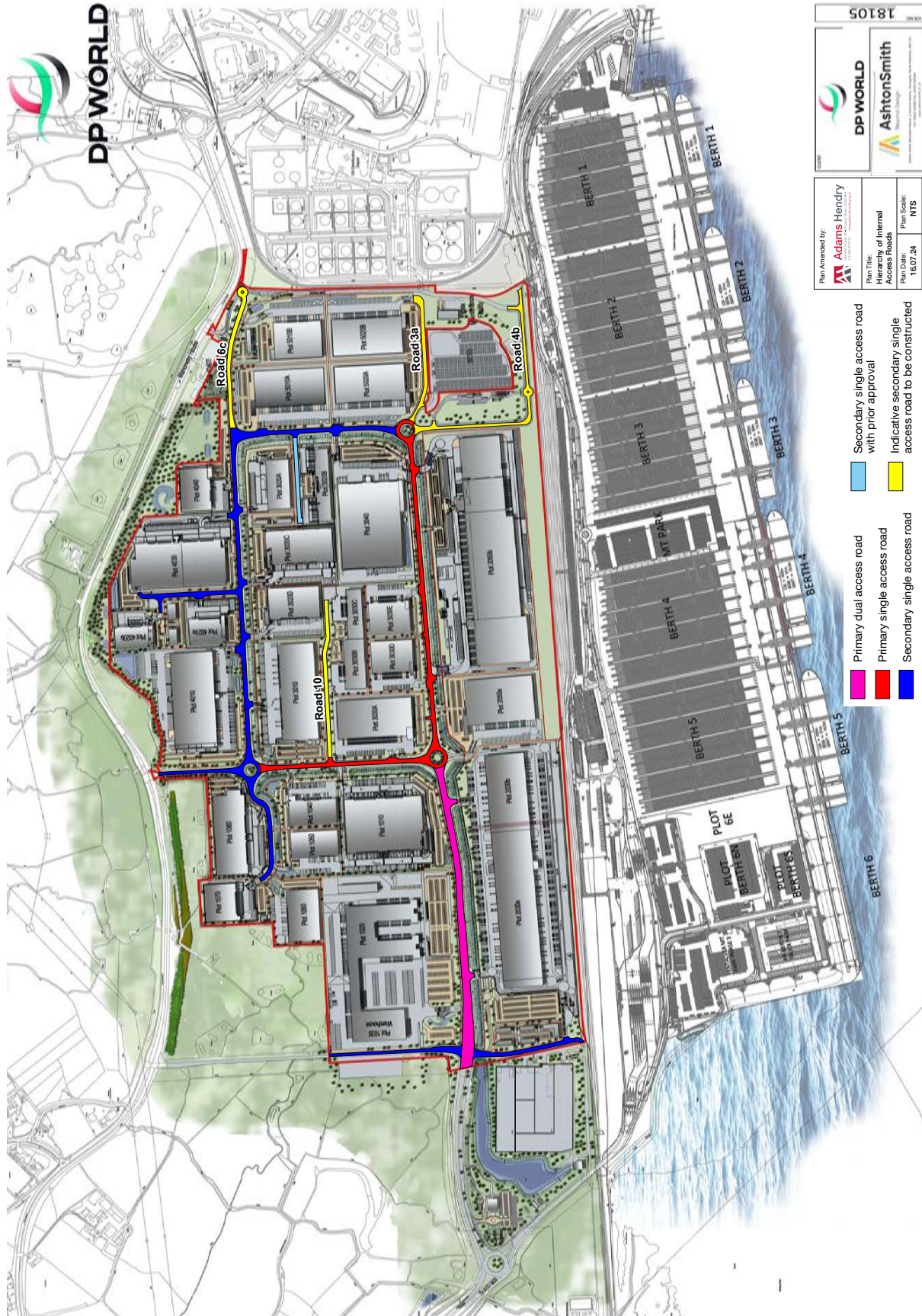

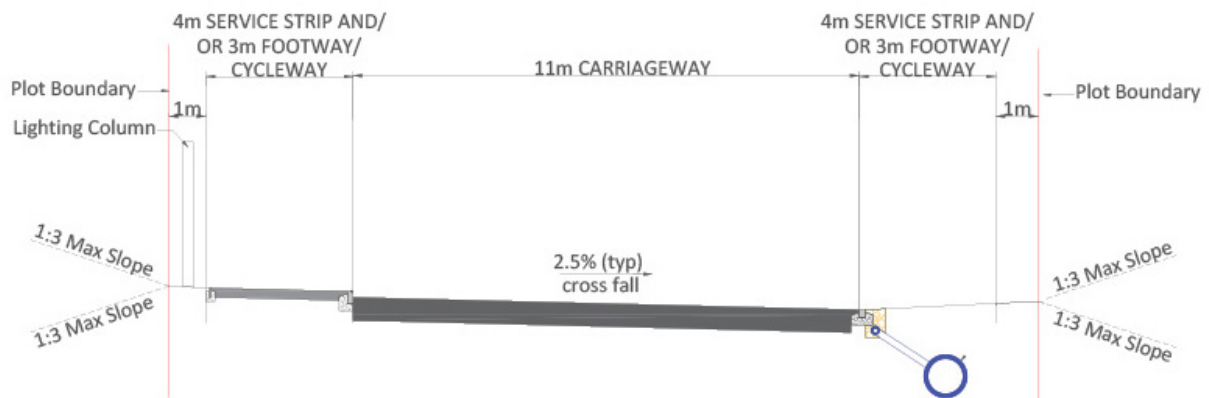
**Figure 20: 11m Single Carriageway Cross Section where a swale is not required**

NB: A footway/cycle way shall be provided on at least one side of the carriageway on Roads 3a, 6c and 10 (see paragraph L1.5 and Figure 17) where there shall be a 11m wide road.

L1.4 As a minimum, a 3m wide footway/cycleway shall be provided on one side of the single secondary access roads marked 3a, 6c and 10 as shown on Figure 17.

L1.5 Save for wayfinding signage all roads shall be constructed in accordance with requirements set out in the Design Manual for Roads and Bridges (DMRB).

L1.6 Security fences or gates shall not obscure sight lines of any junction on the public highway or any vehicular access to the highway.

## L2 Road Drainage

L2.1 The drainage design for the remaining carriageways to be constructed on the Park shall be compliant with DMRB CG 501 – Design of Highway Drainage Systems and shall adopt one of the following systems:

- **Combined surface and sub-surface drains**

An underground porous carrier pipe, bedded in a trench filled with granular material (Type A, B or C, as defined in MCHW Series 0500 [Ref 7.N]).

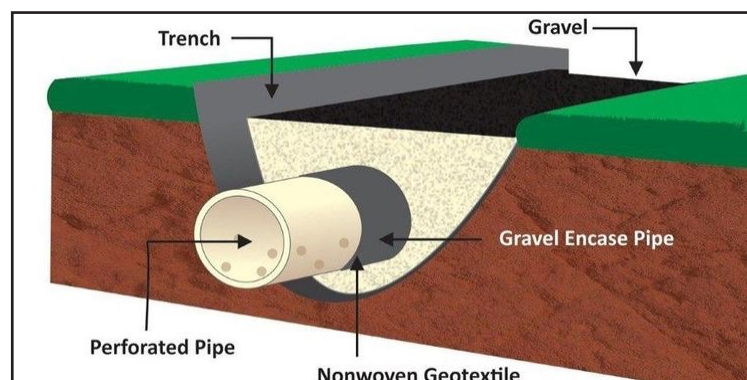



- **Combined kerb and drainage channel**  
Inlets on the kerb face, connected to an enclosed internal drainage channel.

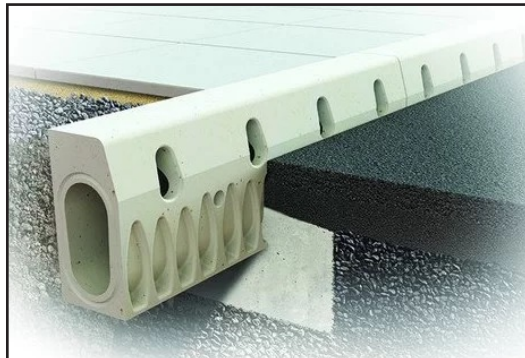

- **Grassed water channels (swales)**  
Grassed drainage channel that runs parallel to edge of the carriageway (see Table 16 for dimensions).



- **Kerbs and gullies**  
Gullies in the carriageway connected to a longitudinal carrier drain, or pipe set, within the road verge.



- **Linear channel drains**  
An underground channel with a covered with a grating.

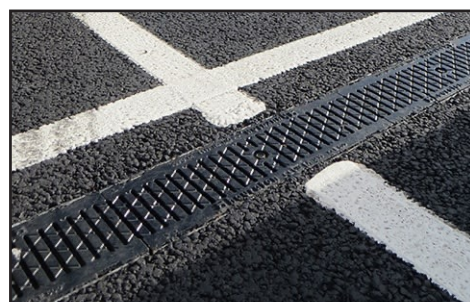

L2.2 The type of road drainage system that is adopted will be dependent on the specific characteristics of the road in the subject location. Where a section of road has:

- Edges of cuttings or is within central reserve, combined surface and sub-surface drains will be adopted; or
- Long stretches with minimal longitudinal gradients of less than 1%, combined surface and sub-surface drains, combined kerb and drainage channels, or grassed water channels (swales) will be adopted; or
- Nosings of interchanges, linear drainage channels or combined kerb and drainage channels will be adopted; or
- Roundabouts, combined kerb and drainage channels or kerbs and gullies will be adopted; or
- Areas of congested public utility services, combined surface and sub-surface drains or combined kerb and drainage channels will be adopted; or
- Areas where level restrictions create shallow outlets to the drainage system, combined kerb and drainage channels will be adopted.

### L3 Pollution Control

L3.1 Equipment to contain spillages including oil booms, drain blockers and dams to contain soluble pollutants, shall be made readily available by London Gateway Services Limited (LGSL).

L3.2 Spillage containment facilities shall be provided at roundabouts and major junctions where an increased risk of vehicle collision/overtaking exists. Slots for stop logs at the upstream end of the culverts shall be included within the design of the culverts.

### L4 Materials

L4.1 Materials for road construction shall be compliant with the appropriate British Standard or other relevant specification.

L4.2 Secondary roads, roundabouts and development plot entrances shall be predominantly asphalt.

L4.3 Standard profile concrete kerbs shall be used adjacent to footpaths / cycleways. High profile concrete kerbs shall be used at HGV entrances and HGV accessible locations.

L4.4 Road marking shall be in white or yellow thermoplastic paint and kerbs shall be used to provide protection to pedestrian areas.

L4.5 When available, suitably recycled, locally sourced and low carbon materials shall be used where these conform to the necessary standards and will meet the necessary performance standards or specification.

### Standards for Footpaths and Cycleways

L4.6 Footways/cycleways shall be a minimum of 3m width.

L4.7 Where footways/cycleways are liable to vehicle over-run, materials shall be restricted to:

- Bituminous materials to DMRB standards unless there is a need to match existing paths surfaced with Hot Rolled Asphalt (HRA).



- Resin bound material – Highways Authorities Product Approval Scheme (HAPAS) certified with a minimum design life of 25 years.
- Where appropriate, concrete block paving, including tumbled blocks, 100mm x 200mm x 80mm.

L4.8 Where the footway will not be over run or otherwise damaged by vehicles the following paving may be used in addition to that noted above.

- 400mm x 400mm x 65mm standard concrete paving slabs.
- 400mm x 400mm x 65mm textured concrete paving slabs.

## L5 Bus routes and facilities

L5.1 An indicative bus route through the logistics park is shown on Figure 21. The timing of the implementation of the bus service shall be agreed with the London Gateway Travel Plan Committee. Raised level bus stop kerbs shall be incorporated along the bus route to create a level entry platform in locations which are to be agreed with the London Gateway Travel Plan Committee.

L5.2 A bus stop flag with timetable case shall be provided at all bus stops. Where appropriate the flag shall be attached to other street furniture to minimise clutter, otherwise it shall be fitted to a proprietary bus stop pole. Bus stop pole, flags and timetable cases shall be from the current range set out in the Essex County Council Street Materials Guide or any such subsequent guidance as may be produced by Thurrock Council.

L5.3 Where provided, bus shelters shall be metal framed in black to RAL 9005, with a low barrelled or vaulted roof. Shelters shall be fitted with end panels to provide protection from the weather with a clear view panel on the bus approach side. Shelters shall be in accordance with the Accessible Bus Stop Design Guide (Bus Priority Team technical advice note BP1/06 January 2006) prepared by Transport for London (TFL) or the latest equivalent guidance.

L5.4 Bus shelters shall be fitted with bench seating with armrests, although perch seating may be installed if space is limited. All bus shelters shall be fitted with plates showing the bus stop name on the kerb face and shall have an information board installed.

## L6 Soft landscaping

### Infrastructure Corridors

L6.1 Landscaping aligning the remaining infrastructure corridors to be constructed shall include a range of planting treatments created in linear sections not exceeding 80m in length and shall be predominantly native and smaller in scale than that on the primary access roads.

L6.2 A native hedgerow shall be planted where 10m planted buffer strips on plots about infrastructure corridors to establish a dense edge and deter access.

L6.3 Service corridors aligning infrastructure corridors shall be predominantly grass seeded or turfed, with the occasional block of ground cover planting to provide low level screening and to discourage public access to the swales.

L6.4 The planting schemes shall take into consideration the required visibility for road users.  
Roundabouts and Plot Entrances

Figure 21: Indicative bus route plan

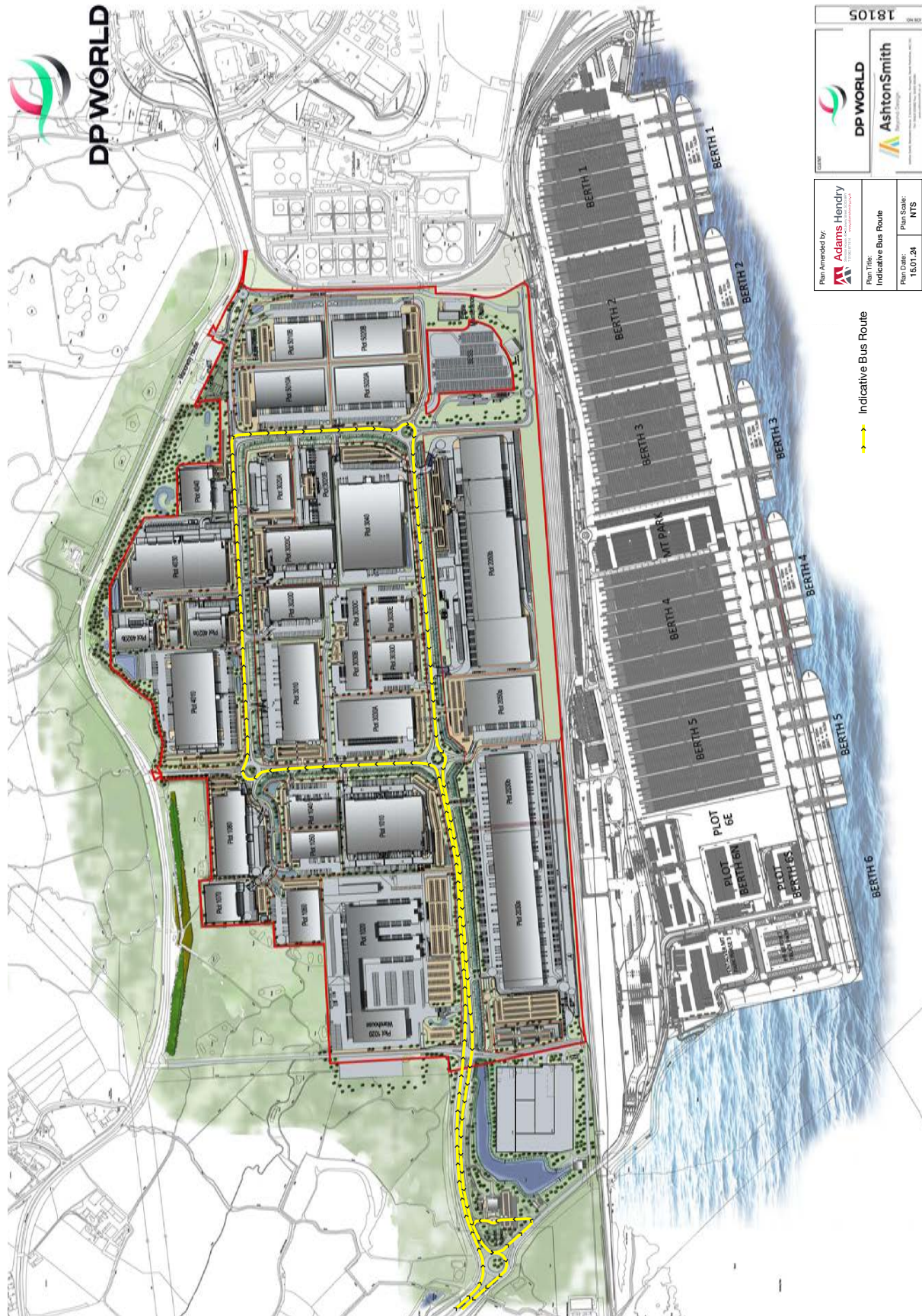

L6.5 Specimen trees, ornamental shrub planting and formal hedgerows shall be permitted at key nodes to provide interest.

## L7 Lighting Requirements

### General Considerations

L7.1 The general standards set out at paragraphs B8.1 – B2, B8.4 - B8.7, B8.9 - B8.10 shall apply to all exterior lighting across the site. References to lighting equipment are indicative and may be amended subject to achieving the stated performance requirements.

L7.2 Lighting equipment when installed, shall meet the lighting constraints defined in ILP Guidance Notes GN01/21 for the control of obtrusive light for the Environmental Zone applicable to the location of the site (see Figure 8). Additional care shall be taken to minimise light spill and glare from any lighting installed by ensuring the correct luminaire is selected and installed in line with the recommendations within CIE 2017 and ILP GN01/21. The design shall ensure the mounting heights employed are the minimum necessary to achieve the lighting performance requirements. Horizontal illuminance levels shall not exceed 1.0 lux at 25m from the Park Site boundary and 0.1 lux at 50m from the Park Site boundary. When lighting levels are measured, meter readings should be within tolerance as per BS667:2005 – Table 2.

L7.3 Lighting columns shall have foundations suited to the ground conditions to maintain lifetime stability and safety and may need to be piled.

L7.4 Where items of equipment outside of plot boundaries may require emergency maintenance works (i.e. penstocks), local task lighting may be installed in accordance with the Chapter 24 of the CIBSE SLL Lighting Handbook 2018. These are to be controlled to ensure that such lighting is only energised during the maintenance operation.

### Lighting Classes

L7.5 The lighting classes for roads footways and cycleways would be as set out in BS 5489-1: 2020 Code of practice for the design of road lighting – Part 1: Lighting of roads and public amenity areas or as subsequently modified and BS EN 13201:2015 Road Lighting. The lighting classes for outdoor work areas would be as set out in BS EN 12464-2:2014 Light and Lighting – Lighting of workplaces; Part 2: Outdoor work places.

### Primary and Secondary Roads

#### Performance Requirements

L7.6 The lighting of secondary roads shall be designed to lighting class ME3b of BS5489-1:2020. The performance requirements are:

Average luminance, $L_{av}$ :	1.0cd/sq.m
Overall Uniformity, $U_o$ :	0.40 minimum
Longitudinal Uniformity, $U_l$ :	0.60 minimum
Threshold Increment, $TI$ :	15% maximum

L7.7 At roundabouts and junctions luminance performance criteria shall not apply and these should be treated as Conflict Areas where CE class illuminance criteria shall apply.



L7.8 At junctions with primary or secondary roads, the lighting shall meet class CE2 of BS 5489-1 2020 and BS EN 13201-2:2015 as follows:

Average illuminance, Eav:	20 lux
Overall Uniformity, Uo:	0.40 minimum

#### Equipment details

Luminaire and lamp:	Blade style luminaire such as the Thorlux Starbeam SB088R5 or equivalent, RA>60, colour <3000K optimised lumen output, incorporating 7 pin mini NEMA socket for lighting management system
Lighting column and bracket:	Thorlux Starbeam or similar, column and bracket or equivalent of 10m maximum height
Mounting attitude:	Zero inclination

#### Installation Geometry

L7.9 Single Carriageway: Lighting columns shall be mounted in a single sided arrangement at the rear of the cycleway/footway with setback in accordance with BS5489-1:2020 at an optimised spacing.

### Lighting for Formal Footways and Cycleways

L7.10 Where there is a footway or cycleway alongside the carriageway, the Edge Illuminance Ratio of the luminaires installed for the carriageway lighting shall provide sufficient lighting of the footway and cycleway without the need for supplementary lighting.

L7.11 Where footways are remote from other lit areas dedicated lighting shall be provided to lighting class S4 of BS 5489-1:2020.

#### Performance Requirements

L7.12 The performance requirement for lighting class P4 is:

Average illuminance, Eav:	5 to 7.5 lux
Minimum illuminance, Emin:	1.0 lux

L7.13 This level can be further reduced dependent upon the Ra and the S/P ratio of the lamp in accordance with Clause A 3.3.3 of BS5489-1:2020.

#### Equipment Details

Luminaire and lamp:	Slade style luminaire such as the Thorlux Starbeam SB088R5 or equivalent, RA>60, Colour < 3000K optimised lumen output incorporating 7 pin mini NEMA socket for lighting management system
Lighting column and bracket:	Raising and lowering column and 0.5m bracket of 5m maximum height.
Mounting attitude:	Zero inclination



### Installation Geometry

L7.14 Single Carriageway: Lighting columns shall be mounted in accordance with the requirements of Paragraph L7.9.

#### Lighting for Bus Stops

L7.15 Lighting columns shall be positioned so as not to obstruct bus doors and shall be located outside the boarding/alighting zone. An enhanced level of street lighting shall not be necessary at bus stops.

L7.16 Electrical supply for bus shelter lighting and communications shall not originate from the street lighting supplies unless it is supplied via a feeder pillar to allow the electricity supply to be isolated.

#### L8 Signage

L8.1 Estate signage shall accord with Traffic Signs Regulations and General Directions 1981 (or any revisions thereto) to maintain a coordinated appearance to the development.

#### L9 Emergency Access

L9.1 Gates 1, 2 and 3 shall be utilised to provide an alternative access route for emergency vehicles and buses and operational vehicles during emergency scenarios. These routes shall comprise a minimum of single lane roadways of 3.7m width with locked gates to the perimeter of the site.

L9.2 Access requirements for fire and rescue vehicles shall comply with Part B, Section 16 of the Building Regulations (Volume 2, 2006 Edition, Amended 2007 and 2010) or as subsequently revised.

### M Park Drainage Standards

#### M1 Surface Water Drainage

M1.1 The runoff from the road network shall drain via a network of swales to a balancing pond (Carter's Bay Lagoon) before being pumped to the River Thames.

#### M2 Swales

M2.1 A network of swales shall act as the arteries of the drainage system, conveying the flow to the balancing pond. The swales will also act as a balancing and storage system under storm conditions.

M2.2 The swales shall be sized to fit within the infrastructure corridor allowed in the Masterplan. The overall widths of the swales may vary between 18m to 26m. The invert level of the swales shall be set at 0.6m AOD at the head falling to Ordnance Datum (0.0m AOD) at the outfall to Carter's Bay Lagoon. Culverts shall be used at road crossings and entrances to plots.

M2.3 The depth of water flow in any swale shall be limited to allow a minimum freeboard 0.25m during the 1 in 100 year event + 25% allowance for climate change to provide a margin of safety against flooding.

M2.4 A typical swale cross section is shown in Figure 22.

**Figure 22: Swale cross section**

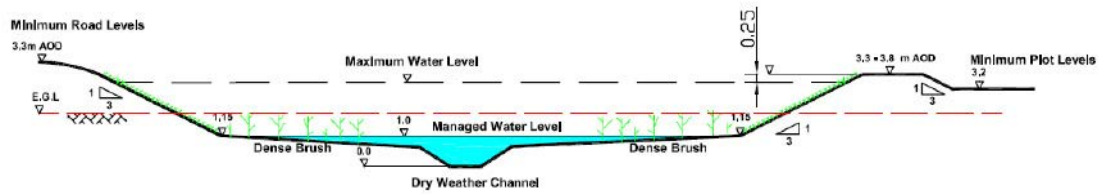

M2.5 The maximum water level at the heads of the swales shall be approximately 3.31m AOD. A minimum clean water flow in the swales shall be ensured at all times to provide the required dilution for the treated sewage effluent discharging from the plots as required by the Environmental Permit.

M2.6 The groundwater table varies across the site. The base of the swales is expected to be permanently submerged within the groundwater table. The groundwater level is expected to be between approximately 1.25m AOD at the head of the system and 1.0m AOD at the receiving lagoon. Adjacent to the permanent water shall be an area of landscaping described as “dense brush”.

**Table 16: Summary of Design Parameters**

Item	Parameter	Nominal	Minimum	Maximum
Swale	Width		18m	26m
	Depth		2.8m	3.4m
	Water level		1m AOD	3.31m AOD
	Water depth		1m	3m
	Side slope	1:3		
	Dry weather channel – side slope	1:2		
	Dry weather channel – base wide	1m		
	Road crossing culvert effective area		2 sq.m	4 sq.m
Design Standard	Swale	1 in 100 year + 25% Climate Change		

M2.7 Plans of the surface water drainage infrastructure shall be submitted to the Lead Local Flood Authority (LLFA) for information no later than the submission date of a prior notification request.

**Planting Regime in Swales and Ponds**

M2.8 The swales shall contain a combination of planting treatments, including meadow and damp tolerant wild flora seeding, marginal / aquatic planting, native shrub planting and standard tree planting. Variation shall be achieved along their length through the use of differing plant species.

M2.9 The composition of the wildflower seed mix shall include species that are able to thrive in drier conditions at the upper margins of wetlands and damp tolerant varieties capable of establishing on the lower slopes.

M2.10 Species selection for marginal plants shall be robust and able to cope with changes in water level. Over time there shall be a subtle adaptation in the planting scheme in response to fluctuations in water level and management techniques.

M2.11 Hedgerows and shrub planting shall be provided along the swale corridor (see Figure 19) to provide low level screening and to discourage public access to the swales and guide movement. Timber knee rails shall be installed as a guide to pedestrians where planting is not otherwise present.

M2.12 Drainage swales aligning the infrastructure corridors shall include a range of native planting treatments along their length. Whilst narrower than those adjacent to the primary internal access roads, drainage swales on secondary single access roads shall still include a range of planting treatments.

M2.13 Steps shall be incorporated into drainage swales to allow access for maintenance and safety. Slopes within swales and water bodies shall not exceed a maximum gradient of 1:3.

M2.14 For safety, where stepped access is not otherwise provided, water bodies shall be designed to accommodate areas where the maximum gradient does not exceed a slope of 1:5.

**Figure 23: The Drainage Swales, Wetlands and Edge Landscape**

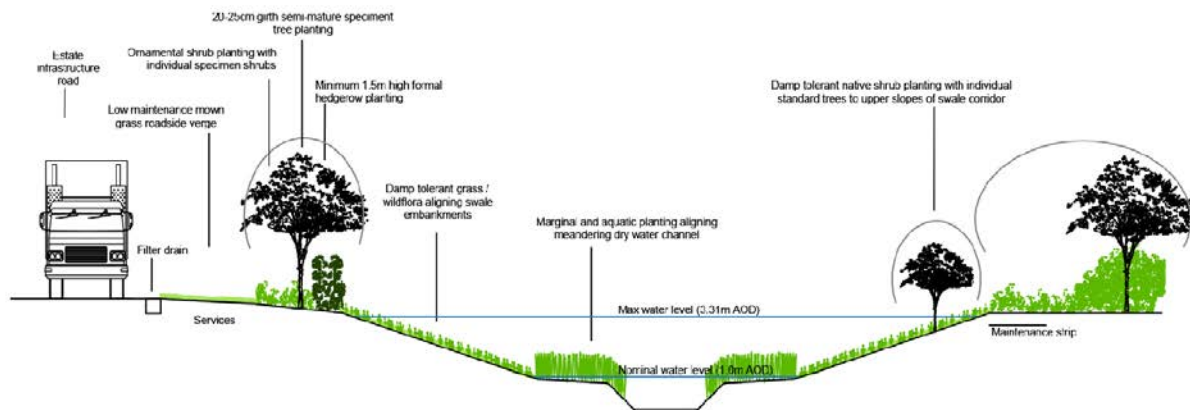

### M3 Standby Generator

M3.1 A standby generator shall be installed adjacent to the pumping station before 515,000 sq.m floorspace (gross internal area (GIA)) is occupied.

### M4 Pollution Control

M4.1 Equipment to contain spillages, including oil booms but also drain blockers and dams to contain soluble pollutants shall be made readily available by LGSL.

M4.2 Slots for stop logs at the upstream end of the culverts carrying the swales beneath Park roads and plot accesses shall be included within the design of culverts.

M4.3 The swale drainage systems may be provided with planting and reedbeds that promote treatment, where feasible to do so, without compromising their primary purpose of conveying water to the pumping stations.

## **M5 Operation and Maintenance**

M5.1 The swale shall be maintained through a simple regime of occasional grass cutting, annual clearance of more excessive vegetation and major clearance / reshaping every 5 to 10 years.

## **N Land Raising**

### **N1 Land Raising**

N1.1 Earth re-profiling shall raise the site to the levels set out in Section D of the CoCP. The raised site shall be tied into the existing landform along its edge at a gradient not exceeding 1:3.

N1.2 The fill material for land raising shall meet the requirements of the Environmental Permit (Reference EPRIYP3691 EK/A001).

## **O General Landscaping Requirements**

### **O1 Soft Landscape Specification**

O1.1 Native shrub, woodland planting and areas of mown and wildflower grassland shall predominate unless otherwise described in this Design Code.

O1.2 Plant species in general will include (but will not necessarily be restricted to) those listed within Appendix 1.

### **O2 Edge of Site**

O2.1 Re-graded slopes to plots shall be aligned along their upper edge by standard trees in a native hedgerow. Understorey and woodland planting will also be established on a minimum of 50% of the remaining slope area.

### **O3 Street Furniture, Boundary Treatments & Feature Elements**

O3.1 Street furniture and boundary features within infrastructure corridors shall be selected to provide visual interest to the scheme and respond to the individual needs of each development phase.

O3.2 Street furniture (i.e. seating, cycle storage) shall be grouped together and located in close proximity to key building entrances.

O3.3 Street furniture products shall be applied in families which are complementary to one another.

### **Finishes**

O3.4 All street furniture items shall conform to the following finishes:

- Timber elements: FSC certified hardwood (Iroko, Oak or similar).
- Stainless steel elements: Grade 316 stainless steel (satin polished or brushed finish).



- Galvanised elements: Hot dip galvanised to BS EN ISO 1461.
- Concrete elements: White / light grey smooth finish.
- Powder coated galvanised mild steel elements: RAL 7016 Anthracite Grey.

O3.5 All boundary treatments shall closely reflect the ranges specified in Part A, Section C2.

### **Bollards:**

- shall be manufactured in galvanised steel or brushed grade 316 stainless steel.
- shall be heavy duty and set in a mass concrete surround (Grade ST4) in areas of HGV use e.g. Broxap 'Manchester' cast iron or similar.
- shall be tubular with a flat or domed top or square with a flat top.
- shall be flexible highway thermoplastic bollards in accordance with DMRB standards where used in central road carriageways.
- may vary in height from 900-1200mm and in section from 76mm to 204mm diameter depending on their intended use.
- may include reflective banding, recessed banding, internal luminaries and other such accessories.
- may be fixed, collapsible, telescopic, retracting or removable depending on their intended use.
- unless required to do otherwise all bollards will be root fixed below ground.



### *Manufacturers (or similar)*

Broxap ([www.broxap.com](http://www.broxap.com))

Bailey Streetscene ([www.baileystreetscene.co.uk](http://www.baileystreetscene.co.uk))

Woodhouse ([www.woodhouse.co.uk](http://www.woodhouse.co.uk))

Heavy Duty Bollard

Steel Bollard

Geo Bollard

### **Seating:**

- shall be composite galvanized steel or brushed grade 316 stainless steel with FSC hardwood timber; or pre-cast smooth finished concrete.
- may include backrests, armrests, centre armrests and anti-skateboard devices.
- shall be root fixed below ground where manufactured in composite steel and timber.
- Concrete seating units will be of sufficient weight to resist movement.



Manufacturers (or similar)

Factory Furniture ([www.factoryfurniture.co.uk](http://www.factoryfurniture.co.uk))  
 Falco ([www.falco.co.uk](http://www.falco.co.uk))  
 Woodhouse ([www.woodhouse.co.uk](http://www.woodhouse.co.uk))

Soca Bench  
 FalcoBloc Bench  
 Geo Bench

**Litter Bins / Cigarette Ash Waste Bins:**

- shall be manufactured in galvanised steel or brushed grade 316 stainless steel and may include areas of FSC hardwood timber.
- shall be root fixed below ground.
- shall have side apertures to minimise rainwater ingress.
- shall be powder coated galvanised steel in RAL 7016 Anthracite Grey
- maintenance access entry points shall be fitted with secure locking devices.



Manufacturers (or similar)

Factory Furniture ([www.factoryfurniture.co.uk](http://www.factoryfurniture.co.uk))  
 Falco ([www.falco.co.uk](http://www.falco.co.uk))  
 Voss (([www.vossstreetfurniture.co.uk](http://www.vossstreetfurniture.co.uk)))

Large Round Bin  
 FalcoBloc Bin  
 LB10t Litter Bin

O3.6 Additional street furniture items may be incorporated into the development. Where required, selection shall reflect the character indicated within the street furniture ranges specified.

O3.7 The detailed specification for boundary treatment set out at Part 1 Section C2 of this document shall also apply across all off-plot areas of the site where required.

*Feature Elements*

O3.8 Lighting of landscaped areas for aesthetic effect may be provided in accordance with the product specification set out at Part 1 Section C3.

**O4 Landscape Management Plan**

O4.1 The management and maintenance of the soft landscape components associated with the development shall be in accordance with the Landscape Management Plan set out at

Appendix 2 to ensure the successful establishment of vegetation and overall integration works within the surrounding landscape.

## **P Service Infrastructure**

P1.0 Service infrastructure upgrades to serve the development have been implemented.

### **P1 Gas Supply**

P1.1 A new gas main has been connected to the existing Mains (high/intermediate/medium pressures) that runs parallel to the Manorway on the northern edge of the site. It is routed through to Gate 2 where it runs in parallel with the central access road to individual plot gas governor/governor meters throughout the Park.

### **P2 Potable and Non-Potable Water Supply**

P2.1 Potable water supply is drawn from the existing Essex and Suffolk network which has been routed throughout the Park via Gates 1 and 2.

P2.2 Measures to reduce potable water consumption shall be implemented where practicable following an appropriate feasibility study. Non-potable water shall be used for landscape maintenance wherever possible through the re-use and recycling of rainwater, the import of treated effluent from nearby wastewater treatment facilities or abstraction from shallow groundwater and/or drainage swales on site, taking account of site constraints and license requirements. Abstractions from controlled water including groundwater shall be undertaken only following due process and permitting under the Water Resources Act. A rainwater harvesting system shall be used to supply all toilets in the buildings. Where occupiers require HGV wash facilities, non-potable water shall be used wherever possible through the re-use of recycling of rainwater unless it can be demonstrated that it is unviable.

### **P3 Electricity Supply**

P3.1 An 11kV distribution network has been installed across the site to serve individual plot requirements. The 11kV distribution network is fed from three 33kV/11kV primary substations, which are fed from the 33kV switching station.

### **P4 Telecommunications**

P4.1 The new fibre optic and traditional copper lines required branch off from the surrounding BT network. In addition a new fibre optic network has been provided. These currently run from The Manorway roundabout to Coryton roundabout parallel with the south side of the road and follow existing cabling through Gate 1 and 3 and along the existing access road.

P4.2 A private fibre optic network has been installed in the infrastructure service corridors to support communications of various items such as CCTV, WLAN, BMS, ANPR and access control systems.

### **P5 Fire fighting systems**

P5.1 Fire hydrants, sprinkler mains and sprinkler storage tanks shall be appropriately sited, as required.

## **P6 Utility Infrastructure**

P6.1 Inspection and access chambers, junction boxes, cabinets and feeder pillars shall be located where they will not affect highway safety, cause unreasonable inconvenience to any user of the road network, or detract from the character of the street.

P6.2 Utility infrastructure shall usually be accommodated within the main infrastructure corridors (within 2m of ground level) and within road verges or footpaths.

P6.3 Alternative routes or variations to the corridor dimension shall be considered where appropriate to meet the specific requirements of a development. To ensure that all parties are agreeable to such alternatives or variations, the developer shall obtain the written agreement of each individual service provider and any other party who would be affected.

## **P7 Sub-stations, Pumping Houses and Other Non-commercial Buildings**

P7.1 Sub-stations, ancillary electrical system stations, transformers, ring main units, pumping houses, and gas kiosks shall be constructed using the following materials:

Sub Stations: GRP, RAL 6005 British Racing Green

Ancillary Electrical System Stations: GRP, RAL 6005 British Racing Green

Transformers: GRP, RAL 6005 British Racing Green

Ring Main Units: GRP, RAL 6005 British Racing Green

Pumping Houses: GRP, to the standard colours set out in Part 1, Section A4.8

Gas Kiosks: Polyester resin, RAL 6005, British Racing Green.

## **P8 HGV fuel and wash facilities serving the Park**

### *Common User HGV Fuelling Facility*

P8.1 All areas of hard standing associated with the active refuelling areas shall be provided with a surface water drainage system fitted with full retention interceptors and installation of penstocks as appropriate for spill management.

P8.2 Fuel storage tanks shall be double skinned and may be either below or above ground. All fuel storage should comply with the relevant conditions from the Control of Pollution (Oil Storage) (England) Regulations 2001 or the most up to date relevant legislation.

P8.3 Fuelling pumps shall be covered with a canopy with a minimum clear height of 6m and a maximum height to the top of the canopy of 9m.

P8.4 HGV fuelling facilities shall be located adjacent to infrastructure corridors.

P8.5 The layout of the HGV fuelling facility shall be designed to allow for the potential provision of electrical charging infrastructure for HGVs.



*Common User HGV Wash facility*

P8.6 Wash facilities must be covered with a maximum height to the top of the enclosure of 7m.

P8.7 Surface water should be excluded from the wash facilities drainage system. Wash facilities drainage shall be contained and not connected to the plot surface water drainage, unless consented by the Environment Agency.

*HGV Washing / Refuelling Lighting*

P8.8 The HGV washing and refuelling lighting shall be in accordance with BS12464-2:2014 Table 5.6. This includes any parking areas, exit and entrance points, checking points and meter reading.

*Performance Requirements*

P8.9 The lighting of HGV refuelling areas shall incorporate ATEX rated luminaires. ATEX generally refers to the hazard of explosive atmospheres due to flammable gasses or combustible dust in the air. The lighting levels shall range from 5 lux average with a uniformity of 0.25 for parking areas up to 150 lux average (under canopy) with 0.4 uniformity for checking points or meter reading areas.

*Lighting Arrangement*

P8.10 The lighting for non-canopied areas shall be column mounted luminaires with up to a 45 degree asymmetric optic to cover the area with a maximum 5 degree tilt where necessary. Under canopied areas the luminaires shall be bulkhead type with a rating of IP65 for ease of maintenance. All luminaires not under canopy shall have an upward light ratio of less than 2.5% at a maximum mounting height of 10m.

**Appendix 1:  
Soft Landscaping Specification**

Soft landscaping across the site shall be selected to provide interest and vibrancy to the development; to meet the specific site conditions experienced at London Gateway; and to optimise wildlife benefit and potential for habitat creation. Selection shall include (but shall not necessarily be restricted to) the following palette of tree, plant and seed species.

## Illustrative Tree Sizes

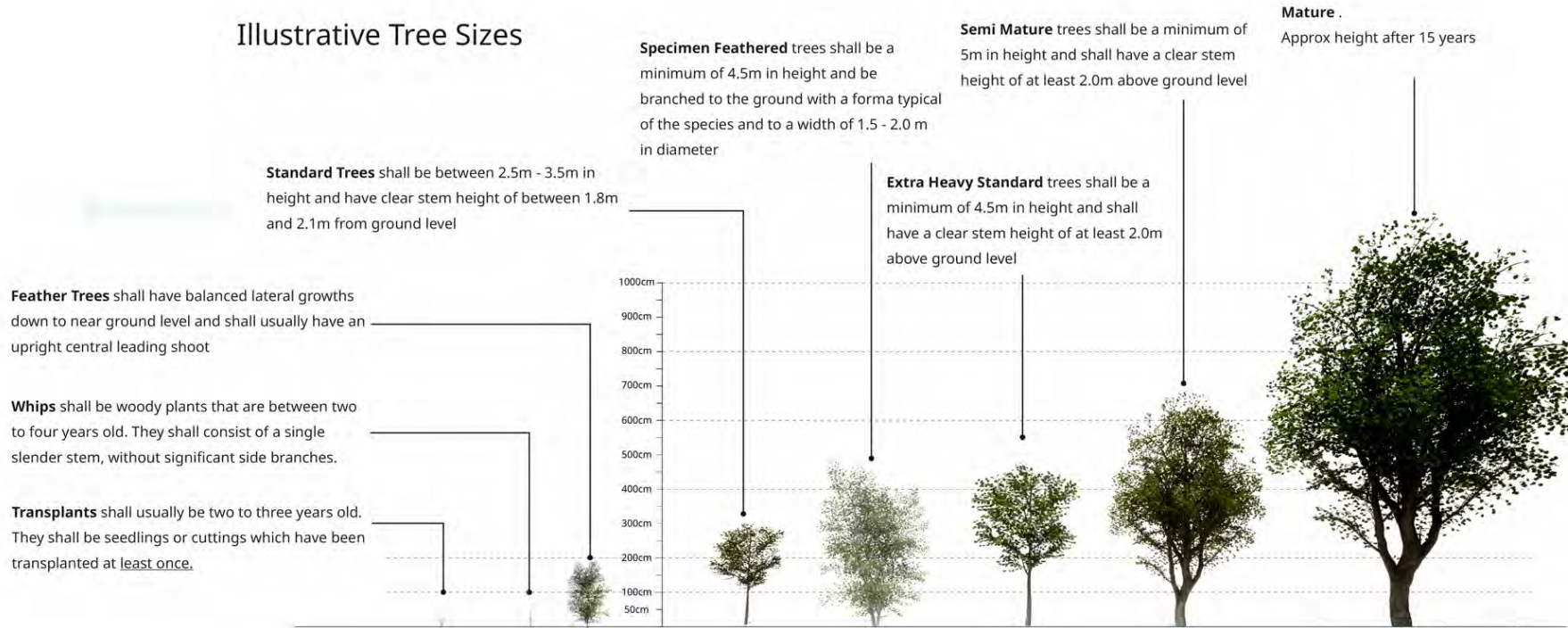

## Specimen Trees

Specimen trees shall include Semi Mature, Extra Heavy Standard and Specimen Feathered species in advanced state of growth. Tree species shall be planted within woodland areas to create a high canopy structure and within the park (singularly, in small groups and as linear blocks) to provide structure and a sense of scale against the large built form. Tree planting aligning the infrastructure roads shall provide a distinctive identity to the park, with larger species focussed at key nodes, such as roundabouts, entrance points, etc. Semi Mature trees shall be secured below ground in 2.0m x 2.0m x1.0m tree pit; Extra Heavy Standards trees shall be supported with double staked, cross bar, rubber tie and spacer in a 1.5m x 1.5m x 1.0m tree pit; Feathered trees shall be supported with double staked, rubber ties and spacers in a 0.6m x 0.6m x 0.6m tree pit, Multistem trees shall be secured below ground in 1.2 x 1.2m x0.8m tree pit.

Where specimen trees... are proposed to be arranged in rows or closely spaced groups these shall be of the same species and specification.

Tree selection shall include, but shall not necessarily be restricted to, the following species.

Species	Form	Minimum	Root Type	Supply	Clear Stem
<i>Alnus incana</i> Laciniata	Semi-Mature	20-25cm girth	Rootballed	5.0-5.5m high	min. 2.0m
<i>Betula utilis</i> Jaquemontii	Semi-Mature	20-25cm girth	Container grown	5.0-5.5m high	min. 2.0m
<i>Carpinus betulus</i>	Semi-Mature	20-25cm girth	Rootballed	5.0-5.5m high	min. 2.0m
<i>Pinus</i> (Austrian Pine)	Semi-Mature	3.0-3.5m high	Rootballed	3.0-3.5m high	Min 0.5m
<i>Pinus sylvestris</i>	Semi-Mature	3.0-3.5m high	Rootballed	3.0-3.5m high	min 0.5m
<i>Prunus avium</i>	Semi-Mature	20-25cm girth	Rootballed	5.0-5.5m high	min. 2.0m
<i>Corbus aria</i> Majestica	Semi-Mature	20-25cm girth	Rootballed	5.0-5.5m high	min. 2.0m
<i>Raxodium distichum</i>	Semi-Mature	20-25cm grith	Rootballed	5.0-5.5m high	min. 2.0m
<i>ber campestre</i>	Extra Heavy Standard	16-20cm	Rootballed	4.5-5.0m high	min. 2.0m
<i>Alnus glutinosa</i>	Extra Heavy Standard	16-20cm	Rootballed	4.5-5.0m high	min. 2.0m
<i>Betula pendula</i>	Extra Heavy Standard	16-20cm	Rootballed	4.5-5.0m high	min. 2.0m
<i>Carpinus betulus</i>	Extra Heavy Standard	16-20cm	Rootballed	4.5-5.0m high	min. 2.0m
<i>Populus tremula</i>	Extra Heavy Standard	16-20cm	Rootballed	4.5-5.0m high	min. 2.0m
<i>Prunus avium</i>	Extra Heavy Standard	16-20cm	Rootballed	4.5-5.0m high	min. 2.0m
<i>Prunus avium plena</i>	Extra Heavy Standard	16-20cm	Rootballed	4.5-5.0m high	min. 2.0m
<i>Quercus robur</i>	Extra Heavy Standard	16-20cm	Rootballed	4.5-5.0m high	min. 2.0m
<i>Salix alba</i>	Extra Heavy Standard	16-20cm	Rootballed	4.5-5.0m high	min. 2.0m
<i>Betula pendula</i>	Feathered	(width 200mm)	Container grown	min 4.0m high	N/A
<i>Betula pubescens</i>	Feathered	(width 200mm)	Container grown	min 4.0m high	N/A
<i>Populus tremula</i>	Feathered	(width 200mm)	Bare root	min 4.0m high	N/A
<i>Amelanchier lamarckii</i>	Multistem	(width 800mm)	Container grown	min 3.0m high	N/A
<i>Amelanchier Ballerina</i>	Multistem	(width 800mm)	Container grown	min 3.0m high	N/A





## Formal Hedgerow Planting

Single species hedgerows shall be used to frame views; provide height to low level planting; and give a formal edge to ornamental shrub planted areas; into trenches wide enough to accommodate root growth; at a minimum density of 4 plants/ linear metre and in a double staggered row.

Species	Specification	Density
Elaeagnos x ebbingei	0.8m-1.0m 15L	4 plants per lin. m
Escallonia rubra macrantha	0.8m-1.0m 15L	4 plants per lin. m
Griselinia littoralis	0.8m-1.0m 15L	4 plants per lin. m
Ligustrum ovalifolium	0.8m-1.0m 15L	4 plants per lin. m
Ligustrum ovalifolium 'Aureum'	0.8m-1.0m 15L	4 plants per lin. m
Prunus lusitanica	0.8m-1.0m 15L	4 plants per lin. m



## Ornamental Shrubs, Grasses and Groundcover Planting

Ornamental shrub planting shall be concentrated within accent locations around the development (e.g., roundabout junctions, plot entrance points, etc.). Planting shall include a combination of taller specimen shrub species (achieving in excess of one metre ultimate height), low ground cover species (averaging 600mm height) and specimen shrub planting to provide stature at key points. Throughout the development, shrubs shall be planted in single species groups of 3 to 50sqm. Detailed shrub selection shall ensure groundcover shrubs and those of a more compact nature are located near to the front of planting beds, with those of a more upright form located further to the rear. Planting design shall take into consideration highway visibility splay requirements, ensuring species selection is appropriate to maintain clear visibility within these areas. Plant selection shall include, but shall not necessarily be restricted to, the following species.

Species	Specification	Density
<b>Shrubs</b>		
Amelanchier canadensis	60-90cm 5L	2 plants per m <sup>2</sup>
Amelanchier lamarckii	60-90cm 5L	2 plants per m <sup>2</sup>
Berberis frikartii 'Amstelveen'	40-60cm 3L	3 plants per m <sup>2</sup>
Ceanothus 'Blue Mound'	40-60cm 3L	3 plants per m <sup>2</sup>
Ceanothus thyrsiflorus repens	40-60cm 3L	3 plants per m <sup>2</sup>
Choisya ternata 'Sundance'	60-90cm 5L	3 plants per m <sup>2</sup>
Choisya x dewitteana 'White Dazzler'	60-90cm 5L	3 plants per m <sup>2</sup>
Cistus 'Silver Pink'	30-40cm 3L	3 plants per m <sup>2</sup>
Cistus x corbariensis	30-40cm 3L	3 plants per m <sup>2</sup>
Cistus x purpureus	30-40cm 3L	3 plants per m <sup>2</sup>
Cornus alba 'Elegantissima'	60-90cm 5L	2 plants per m <sup>2</sup>
Cornus alba 'Sibirica'	60-90cm 5L	2 plants per m <sup>2</sup>
Cornus Baton Rouge	60-90cm 5L	3 plants per m <sup>2</sup>
Cornus stolonifera 'Flaviramea'	60-90cm 5L	3 plants per m <sup>2</sup>



Cytisus 'Boskoop Ruby'	30-40cm 3L	4 plants per m <sup>2</sup>
Cytisus scoparius	30-40cm 3L	4 plants per m <sup>2</sup>
Escallonia 'Red Dream'	60-90cm 5L	3 plants per m <sup>2</sup>
Euonymus japonicus 'Chedju'	40-60cm 3L	3 plants per m <sup>2</sup>
Hebe brachysiphon 'Wiri Mist'	30-40cm 3L	4 plants per m <sup>2</sup>
Hebe Green Gem	20-30cm 3L	5 plants per m <sup>2</sup>
Hebe pinguifolia 'Sutherlandii'	20-30cm 3L	5 plants per m <sup>2</sup>
Hebe 'Sapphire'	40-60cm 3L	3 plants per m <sup>2</sup>
Hebe vernicosa	40-60cm 3L	3 plants per m <sup>2</sup>
Hebe x franciscana 'Blue Gem'	20-30cm 3L	5 plants per m <sup>2</sup>
Hydrangea macrophylla 'Amethyst'	60-90cm 5L	3 plants per m <sup>2</sup>
Hydrangea macrophylla 'Magical'	60-90cm 5L	3 plants per m <sup>2</sup>
Lavandula hidcote	20-30cm 3L	5 plants per m <sup>2</sup>
Lavandula intermedia 'Grosso'	20-30cm 3L	5 plants per m <sup>2</sup>
Lonicera nitida 'May green'	30-40cm 3L	4 plants per m <sup>2</sup>
Lonicera nitida 'Baggesen's Gold'	30-40cm 3L	4 plants per m <sup>2</sup>
Lonicera pileata	30-40cm 3L	4 plants per m <sup>2</sup>
Ligustrum aureum	40-60cm 3L	3 plants per m <sup>2</sup>
Mahonia aquifolium 'Apollo'	40-60cm 3L	3 plants per m <sup>2</sup>
Mahonia x media 'Winter Sun'	60-90cm 5L	2 plants per m <sup>2</sup>
Osieria haastii	40-60cm 3L	3 plants per m <sup>2</sup>
Osieria burkwoodii	40-60cm 3L	3 plants per m <sup>2</sup>
Philadelphus 'Belle Etoile'	40-60cm 3L	3 plants per m <sup>2</sup>
Philadelphus 'Snowbelle'	40-60cm 3L	3 plants per m <sup>2</sup>
Pinus mugo	30-40cm 5L	3 plants per m <sup>2</sup>
Pinus mugo Mini Mops	30-40cm 5L	4 plants per m <sup>2</sup>
Pittosporum tenuifolium	40-60cm 3L	3 plants per m <sup>2</sup>
Pittosporum tenuifolium 'Tom Thumb'	30-40cm 3L	4 plants per m <sup>2</sup>
Rosmarinus 'Miss Jessopp's Upright'	30-40cm 3L	4 plants per m <sup>2</sup>
Salix eleagnos 'Rosmarinifolia'	60-90cm 5L	2 plants per m <sup>2</sup>
Sambucus Black Lace	60-90cm 5L	2 plants per m <sup>2</sup>
Spiraea japonica 'Anthony Waterer'	40-60cm 3L	3 plants per m <sup>2</sup>
Spiraea japonica 'Firelight'	40-60cm 3L	3 plants per m <sup>2</sup>
Viburnum opulus	40-60cm 3L	2 plants per m <sup>2</sup>
Viburnum tinus 'Eve Price'	60-90cm 5L	3 plants per m <sup>2</sup>





Viburnum tinus 'Gwenllian'	60-90cm 5L	3 plants per m <sup>2</sup>
Vinca minor	15-20cm 3L	6 plants per m <sup>2</sup>
Weigela 'Bristol Ruby'	40-60cm 3L	3 plants per m <sup>2</sup>

**Grasses**

Calamagrostis 'Karl Foerster'	Full Pot 3L	4 plants per m <sup>2</sup>
Stipa tenuissima 'Pony Tails'	Full Pot 3L	4 plants per m <sup>2</sup>
Phormium 'Platts Black'	Full Pot 3L	3 plants per m <sup>2</sup>
Pennisetum alopecuroides	Full Pot 3L	4 plants per m <sup>2</sup>
Panicum virgatum 'Shenandoah'	Full Pot 3L	4 plants per m <sup>2</sup>
Panicum virgatum 'Prairie Sky'	Full Pot 3L	4 plants per m <sup>2</sup>
Miscanthus sinensis 'Gracillimus'	Full Pot 3L	4 plants per m <sup>2</sup>
Miscanthus 'Kleine Silberspinne'	Full Pot 3L	4 plants per m <sup>2</sup>
Miscanthus sinensis 'Zebrinus'	Full Pot 3L	4 plants per m <sup>2</sup>
Carex oshimensis 'Evergold'	Full Pot 3L	4 plants per m <sup>2</sup>
Carex buchananii 'Red Rooster'	Full Pot 3L	4 plants per m <sup>2</sup>

**Hebeaceous**

Geranium 'Brookside'	Full Pot 3L	6 plants per m <sup>2</sup>
Geranium 'Johnson's Blue'	Full Pot 3L	6 plants per m <sup>2</sup>
Ageria maritima 'Splendens'	Full Pot 3L	8 plants per m <sup>2</sup>
Pyngium x zabelii 'Jos Eijking'	Full Pot 3L	4 plants per m <sup>2</sup>
Heuchera 'Palace Purple'	Full Pot 3L	6 plants per m <sup>2</sup>
Heuchera Lime Marmalade	Full Pot 3L	6 plants per m <sup>2</sup>
Perovskia 'Blue Spire'	Full Pot 3L	4 plants per m <sup>2</sup>
Verbena bonariensis	Full Pot 3L	4 plants per m <sup>2</sup>



## Native Woodland Planting

Woodland planted areas shall establish to form the upper canopy structure across the Development. Species selection and percentage mix shall conform to the densities provided below, with plants arranged on a 1.0m x 1.5m grid. Tree species shall be planted in single species groups of 3-5 within the planting matrix and understorey plants in single species groups of 7-15. Extra Heavy Standard and Feathered trees shall be planted in single species groups at minimum 3.0m spacing. All woodland understorey planting shall be fitted with robust grow tubes supported with a 50x50mm treated softwood stake and all trees mulched (600mm diameter @

Species	Form	size	specification	Height	%
<b>Trees</b>					
Acer campestre	Extra Heavy Standard	14-16cm girth	Rootballed	4.25-5.00m high	3%
Populus var betulifolia	Extra Heavy Standard	14-16cm girth	Rootballed	4.25-5.00m high	2%
Populus tremula	Extra Heavy Standard	14-16cm girth	Rootballed	4.25-5.00m high	3%
Prunus avium	Extra Heavy Standard	14-16cm girth	Rootballed	4.25-5.00m high	2%
Quercus robur	Extra Heavy Standard	14-16cm girth	Rootballed	4.25-5.00m high	3%
Sorbus aucuparia	Extra Heavy Standard	14-16cm girth	Rootballed	4.25-5.00m high	2%
Acer campestre	Feathered		Bare root	1.75-2.00m high	5%
Populus var betulifolia	Feathered		Bare root	1.75-2.00m high	3%
Populus tremula	Feathered		Bare root	1.75-2.00m high	3%
Quercus robur	Feathered		Bare root	1.75-2.00m high	4%
Sorbus aucuparia	Feathered		Bare root	1.75-2.00m high	3%
<b>Understorey</b>					
Acer campestre	Transplant (2+1)		Bare root	60-90cm high	4%
Corylus avellana	Transplant (2+1)		Bare root	60-90cm high	15%
Crataegus monogyna	Transplant (2+1)		Bare root	60-90cm high	15%
Ilex aquifolium	Shrub		5L	60-90cm high	5%
Ligustrum vulgare	Shrub		5L	60-90cm high	5%
Juniperus communis	Shrub		5L	60-90cm high	5%
Taxus baccata	Shrub		5L	60-90cm high	5%
Prunus spinosa	Transplant (2+1)		Bare root	60-90cm high	5%
Quercus robur*	Transplant (2+1)		Bare root	60-90cm high	3%
Salix caprea	Transplant (2+1)		Bare root	60-90cm high	5%





## Understorey Native Shrub Planting

Native shrub planting shall be predominate across the development. In combination with Native Woodland planting, it shall create the basis of the landscape infrastructure, providing seasonal interest and the creation of wildlife habitat. Species selection and percentage mix shall conform to the densities provided below, with plants arranged on a 0.75 x 0.75m grid in single species groups of 7-15. Native understorey planting to high profile areas shall be mulched to a depth of 60mm, all stock shall be fitted with robust grow tubes supported with a 50x50mm treated softwood stake.

Species	Form	Specification	Height	%
<b>Understorey</b>				
Cornus sanguinea	Transplant (2+1)	Bare root	60-90cm high	10%
Corylus avellana	Transplant (2+1)	Bare root	60-90cm high	15%
Crataegus monogyna	Transplant (2+1)	Bare root	60-90cm high	20%
Euonymus europaeus	Transplant (2+1)	Bare root	60-90cm high	5%
Ilex aquifolium	Shrub	3L	40-60cm high	7.5%
Juniperus communis	Shrub	3L	40-60cm high	7.5%
Ligustrum vulgare	Shrub	3L	40-60cm high	10%
Prunus spinosa	Transplant (2+1)	Bare root	60-90cm high	10%
Raxus baccata	Shrub	3L	40-60cm high	7.5%
Viburnum opulus	Transplant (2+1)	Bare root	60-90cm high	7.5%



## Native Hedgerow Planting

Native hedgerows shall be used to provide a dense, formal edge to native woodland and understorey planted areas. Incorporating a range of species, they shall provide seasonal interest and create a diverse wildlife habitat. Species selection and percentage mix shall conform to the densities provided below, with plants arranged into trenches wide enough to accommodate root growth; at a minimum density of 7 plants/ linear metre; and in a triple staggered row, in single species groups of 3-10 plants. The base of hedgerows shall be mulched to suppress weed growth. ... All stock shall be fitted with robust grow tubes supported with a 50x50mm treated softwood stake.

Species	Form	Specification	Height	%
Cornus sanguinea	Transplant (2+1)	Bare root	60-90cm high	10%
Corylus avellana	Transplant (2+1)	Bare root	60-90cm high	15%
Crataegus monogyna	Transplant (2+1)	Bare root	60-90cm high	20%
Euonymus europaeus	Transplant (2+1)	Bare root	60-90cm high	10%
Ilex aquifolium	Shrub	5L	60-90cm high	7.5%
Ligustrum vulgare	Shrub	5L	60-90cm high	20%
Prunus spinosa	Transplant (2+1)	Bare root	60-90cm high	10%
Viburnum opulus	Transplant (2+1)	Bare root	60-90cm high	7.5%



## Wetland Margin / Swale Planting

Native tree and shrub planting shall be established to the upper slopes of wetland areas and swales. Species selection and percentage mix shall conform to the densities provided below, with plants arranged on a 1.0 x 1.0m grid. Tree species (\*) shall be planted in single species groups of 3-5 within the planting matrix and shrubs planted in single species groups of 7-15. Standard trees shall be planted at minimum 3.0m spacings within the matrix. Wetland marginal planting shall include a weed suppress weed growth and reduce maintenance requirements. All stock shall be fitted with robust grow tubes supported with a 50x50mm treated softwood stake.

Species	Form	Root Type	Height	%
Acer campestre	Standard (8-10cm)	Bare Root	2.5-3.0m high	2
Alnus glutinosa	Standard (8-10cm)	Bare Root	2.5-3.0m high	4
Prunus avium	Standard (8-10cm)	Bare Root	2.5-3.0m high	2
Quercus robur	Standard (8-10cm)	Bare Root	2.5-3.0m high	2
Salix alba	Standard (8-10cm)	Bare Root	2.5-3.0m high	2
Acer campestre*	Transplant (1+1)	Bare Root	40-60cm high	3
Alnus glutinosa*	Transplant (1+1)	Bare Root	40-60cm high	9
Corylus avellana	Transplant (1+1)	Bare Root	40-60cm high	9
Corytaegus monogyna	Transplant (1+1)	Bare Root	40-60cm high	35
Prunus spinosa	Transplant (1+1)	Bare Root	40-60cm high	5
Quercus robus*	Transplant (1+1)	Bare Root	40-60cm high	5
Salix alba*	Transplant (1+1)	Bare Root	40-60cm high	10
Salix caprea	Transplant (1+1)	Bare Root	40-60cm high	7



## Marginal / Aquatic Planting

Water bodies and drainage balancing features shall include extensive areas of marginal planting. Shallow planting shelves shall be incorporated into the design of balancing ponds and drainage swales to optimise the visual and habitat benefits of these features. Marginal and aquatic species shall be planted at 5 plants / per sqm. in single species groups of 20-30 plants randomly throughout wetland areas.

Species	Common Name
Callitriche stagnalis	Common water starwort
Lythrum salicaria	Purple-loosestrife
Mentha aquatica	Water mint
Myosotis scorpioides	Water forget me not
Phragmites australis	Common reed
Potamogeton crispus	Curled pondweed
Potamogeton pectinatus	Fennel-like pondweed
Ranunculus aquatilis	Water crowfoot
Veronica beccabunga	Brookline



## Seed Mixes

Grass and wildflora seed mixes shall be applied at a rate in accordance with suppliers recommendations. Indicated specification for wildflower areas and wetland / swale areas assumes the use of a clay based landscape fill material. Specification for these areas shall be amended as necessary to reflect findings from soil assessments and agreed with project ecologists prior to sowing.



### Seed Mix for Mown Grass Areas

Seed mix for mown grass areas shall be applied to roadside verges, service corridors, within visibility splays, roundabout margins and soft landscaped areas where a more managed appearance is desired.

### Seed Mix for Wetland / Swale Areas

Seed mix for wetland / swale areas shall be applied to the embankments of balancing ponds, swales and ditches across the development.

### Seed Mix for Shaded Areas

Seed mix for shaded areas shall be applied beneath areas of native woodland planting and understorey native shrub planting to suppress weed establishment.

### Seed Mix for Wildflower Areas

Seed mix for wildflower areas shall be applied within open areas where a more 'naturalistic' appearance is acceptable and where temporary earthworks are required.

Species	% Mix	Wildflora Species (20%)	Grass Species (80%)	Wildflora Species	% Mix	Wildflora Species (20%)	Grass Species (80%)
<i>Festuca rubra rubra</i>	30	<i>Achillea ptarmica</i>	<i>Agrostis capillaris</i>	<i>Festuca rubra</i>	25	<i>Achillea millefolium</i>	<i>Agrostis capillaris</i>
<i>Lolium perenne</i>	25	<i>Angelica sylvestris</i>	<i>Alopecurus pratensis</i>	<i>Festuca arundinacea</i>	25	<i>Centaurea nigra</i>	<i>Alopecurus pratensis</i>
<i>Festuca brevipila</i>	20	<i>Caltha palustris</i>	<i>Anthoxanthum odoratum</i>	<i>Cynosurus cristatus</i>	20	<i>Galium verum</i>	<i>Anthoxanthum odoratum</i>
<i>Cynosurus cristatus</i>	12.5	<i>Cardamine partensis</i>	<i>Cynosurus cristatus</i>	<i>Phleum bertolonii</i>	5	<i>Leucanthemum vulgare</i>	<i>Cynosurus cristatus</i>
<i>Agrostis capillaris</i>	10	<i>Filipendula ulmaria</i>	<i>Deschampsia cespitosa</i>	<i>Poa nemoralis</i>	5	<i>Lotus comiculatus</i>	<i>Festuca rubra</i>
<i>Trifolium repens</i>	2.5	<i>Hypericum tetrapterum</i>	<i>Festuca rubra</i>	<i>Stachys sylvatica</i>	3	<i>Plantago lanceolata</i>	<i>Phleum bertolonii</i>
		<i>Iris pseudacorus</i>		<i>Borago officinalis</i>	2.2	<i>Primula veris</i>	
		<i>Lotus pedunculatus</i>		<i>Silene dioica</i>	2	<i>Prunella vulgaris</i>	
		<i>Lycopus europaeus</i>		<i>Silene latifolia</i>	2	<i>Ranunculus acris</i>	
		<i>Lythrum salicaria</i>		<i>Geum urbanum</i>	2	<i>Rhinanthus minor</i>	
		<i>Pulicaria dysenterica</i>		<i>Teucrium scorodonia</i>	1.5	<i>Rumex acetosa</i>	
		<i>Ranunculus acris</i>		<i>Galium album</i>	1.1	<i>Silaum silaus</i>	
		<i>Scrophularia auriculata</i>		<i>Tori japonica</i>	1	<i>Silene flos-cuculi</i>	
		<i>Silene</i>		<i>Filipendula ulmaria</i>	1	<i>Trifolium pratense</i>	
		<i>Succisa pratensis</i>		<i>Hypericum perforatum</i>	1	<i>Vicia cracca</i>	
				<i>Malilotus albus</i>	1		
				<i>Hyacinthoides non-scripta</i>	0.5		
				<i>Stellaria holostea</i>	0.5		
				<i>Digitalis purpurea</i>	0.4		
				<i>Lychnis flos-cuculi</i>	0.4		
				<i>Clematis vitalba</i>	0.3		
				<i>Allium ursinum</i>	0.1		

## Landscape Soils

The development shall include a significant amount of earth re-profiling to raise the site. In addition to the main land raise elements, significant earth shaping shall take place on the individual plots and phases to include mounding and sculpting to enhance enclosure and accommodate drainage requirements. An engineered fill layer shall be used to raise the site and a new 'landscaping soil profile' (to include topsoil and subsoil layers) shall be placed over this fill layer to provide appropriate growing conditions in areas to receive soft landscaping.

Different planting environments require certain soil properties in order to meet their inherent cultural requirements and to minimise the stress caused during transplanting and the establishment phase of a new landscape scheme. In order to ensure that each planting environment has soils that meet its specific requirements, a series of soil types that are likely to be required for the landscape scheme have been identified (see Table 1 below).

**Table 1: Soil Types**

Soil Type	Planting Environment
Multi-Purpose Topsoil #	Specimen trees in soft landscape areas Ornamental shrubs and groundcover planting Formal hedgerow planting Native woodland planting Understorey native shrub planting Native hedgerow planting Mown grass areas Meadow grass for shaded areas
Low Fertility Topsoil	Wetland margin / swale planting Marginal / aquatic planting Willflower seeded areas (sp. wildflower) Damp tolerant seeded areas (i.e swales / wetlands)
Landscape Subsoil	All soft landscape areas
Urban Tree Soil	Specimen trees in hard landscape areas
Washed Sand	Specimen trees in hard landscape areas

# localised adjustments to composition and fertility may be made to suit specific requirements of certain species

Multi-Purpose Topsoil shall either have the soil characteristics of Multipurpose Topsoil (as defined within BS33882:2015) or be a manufactured topsoil specifically developed by a suitably qualified soil scientist to meet the demands of the proposed planting types and species.

Low Fertility Topsoil shall either have the soil characteristics of Specific Purpose - Low Fertility Topsoil (as defined within BS33882:2015) or be a manufactured topsoil specifically developed by a suitably qualified soil scientist to meet the demands of the proposed planting types and species.

Landscape Subsoil shall be a Class 4 granular fill material with a moderate to high drainage rate in order to compliment the overlying topsoils. The quality of the subsoil shall be suitable for the proposed planting types and species.

Urban Tree Soil shall be an engineered topsoil specifically designed to leave space for air, water and root growth and prevent subsidence of the surrounding area.

Washed Sand shall be used as subsoil in the lower part of specimen tree pits in hard landscape areas. Washed sand shall be a suitably graded, quarried washed sand that shall provide sufficient porosity when in a compacted state to allow suitable drainage and aeration.

All landscape soils shall be tested to ensure they are not contaminated with hazardous material or substances including controlled waste: or hazardous wastes: or radioactive wastes. All topsoils shall be tested to ensure they do not contain concentrations of toxins, pathogens or other extraneous substances harmful to plant life. All soils shall be handled in accordance with best practice.

Landscape soils shall be deposited to the vertical depths indicated in Table 2 below.

**Table 2: Soil Profiles**

Planting Type	Topsoil Thickness	Subsoil Thickness	Soil Profile Thickness
Specimen trees in soft landscape areas	350mm	650mm	1000mm'
Specimen trees in hard landscape areas	600mm	400mm	1000mm
Ornamental shrubs and groundcover planting	350mm	650mm	1000mm'
Formal hedgerow planting	400mm	600mm	1000mm'
Native woodland planting	300mm	700mm	1000mm'
Understorey native shrub planting	300mm	700mm	1000mm'
Native hedgerow planting	300mm	700mm	1000mm'
Wetland margin / swale planting	300mm	200mm	Variable
Marginal / aquatic planting	300mm	200mm	Variable
Mown grass areas	150mm	350mm	500mm
Meadow grass for shaded areas	150mm	350mm	500mm
Willflower seeded areas	150mm	350mm	500mm
Damp tolerant seeded areas	150mm	350mm	500mm

\* a proportion of this layer may need to be replaced with gravel for drainage or water attenuation purposes.

## Tree Pits

Tree species shall be planted into pits of sizes as indicated in Table 3 below:

**Table 3: Tree Pit Sizes and Hedge Trench Sizes**

Tree Size	Tree Pit Size
Whips and feathered trees up to 2.5m in height	600 x 600 x 600mm depth
Formal and informal hedgerows	Trenches sufficient to accommodate roots when fully spread
Standard trees	800 x 800 x 600mm depth
Extra heavy standard and feathered specimen trees	1500 x 1500 x 1000mm depth
Semi mature trees	2000 x 2000 x 1000mm depth



**Appendix 2:  
Landscape Management Plan**

## Appendix 2 - Landscape Management Plan

### Introduction

This appendix sets out the requirements for the maintenance of landscape works within the London Gateway Commercial & Logistics Park Development (the development). The scope of this report provides a strategy for the management of existing habitats, new habitats and amenity landscape associated with the development.

The overall aim is to adopt a coherent, strategic and integrated approach to the management and maintenance of the soft landscape components associated with the development; ensuring the successful establishment of vegetation and overall integration works within the surrounding landscape. A management approach that is appropriate to both nature conservation and the users of the site and its amenity.

### Key Objectives

- To retain and enhance the value of existing landscape features;
- To successfully establish and integrate new landscape proposals and site vegetation with the surrounding landscape;
- To maximise the nature conservation value of both new and existing habitats on the site;
- To accommodate appropriate public use of the site, by promoting a management regime which is appropriate to the site's role;
- To fulfil legal requirements, including nature conservation, environmental protection and general public safety; and
- To ensure the successful establishment and managed growth of all planting and seeded areas.

### Description of the Works

The works are applicable to the maintenance of proposed trees, shrubs, hedgerows, woodland planting, mown grass and meadow grass areas to be implemented; any street furniture or paving to be installed; and any existing vegetation to be retained as part of the Development.

Maintenance work within these areas may include:

- Ground preparation;
- Minor topsoiling;
- Grass cutting;
- Edge trimming;
- Tree, hedge and shrub pruning;
- General tree care;
- Watering;
- Treatment of pests and diseases;
- Creation of habitat features;
- Woodland management;

## Landscape Management Requirements

### General Maintenance Requirements

There are a number of general prescriptions that apply to management of the development. These are:

- All legally designated weeds or invasive plants (identified in Schedule nine, Part II of the Wildlife and Countryside Act 1981 or the Weeds Act 1959) shall be controlled and disposed of in accordance with relevant Natural England; DEFRA; or Environment Agency guidance;
- Vegetation, which suppresses or otherwise inhibits the development of planted species and proper management of habitats shall be restricted and/ or removed;
- Any species which colonise the site, and are incongruous with the planting scheme and / or the surrounding context, shall be removed;
- All areas will be subject to a regular system of litter collection and removal;
- All swale and water body embankments will be subject to regular vegetation clearance, to ensure that a Manning coefficient of 0.075 can be maintained;
- All permanent water channels will be subject to regular vegetation clearance, to ensure that a Manning coefficient of 0.01 can be maintained.

## Street Furniture

### General

### Maintenance

Contractors will undertake the following operations to all street furniture items throughout the life of the development:

- Surface cleaning (in accordance with guidance below);
- Inspect and notify facilities management team of superficial or physical damage to street furniture items; and
- Inspect and tighten (as necessary) all fixtures and fixings.

### Cleaning Requirements

#### Timber Surfaces

- Clean annually with a stiff brush to prevent a verdigris type build up;
- Remove and sand with 100 grit sandpaper any splinters and graffiti; to ensure an even and smooth surface finish.

#### Galvanised Surfaces

- Clean quarterly using a damp cloth and warm soapy water only.  
NB: Scourers and abrasive cleaners are NOT suitable for these types of finish and may damage them.

#### Powder Coated Surfaces

- Clean quarterly using a damp cloth and warm soapy water only.  
NB: Scourers and abrasive cleaners are NOT suitable for these types of finish and may damage them.

#### Stainless Steel

- Clean quarterly using a stainless steel polish and a lint free cloth.  
NB: To remove ground in dirt a stainless steel finishing pad may be required.

#### Concrete

- Clean annually using an abrasive sponge and warm soapy water only.

## Feature Planting

### Semi Mature, Extra Heavy Standard & Specimen Feathered Tree Planting

#### Establishment Maintenance

To ensure their survival and optimal development, these trees will be subject to intensive establishment maintenance. Contractors will undertake the following operations as necessary during the first 24 months after planting:

- Maintenance of a 1.2m diameter weed free area around the base of each tree, through the application of a 75mm depth mulch, keeping a 200mm diameter at the base of the bole free of mulch to prevent basal rot of the bole. Additional spot treatment of using a glyphosphate based herbicide only or hand weeding if necessary to ensure the base of the tree is weed free;
- Treatment against pests and diseases with spraying and dusting;
- Application of a slow release fertiliser around the base of all trees to ensure soil fertility is maintained at appropriate levels;
- Inspection, adjustment and maintenance of guards, stakes, anchors and ties;
- Adjustment, re-firming and replacing guys, stakes and ties. Replace broken or missing items, adjust if necessary to allow for growth and prevent rubbing of bark;
- Re-firming of plants after strong winds, frost heave or other disturbances;
- Watering of plants to ensure moisture levels are maintained appropriate for optimum growth; and
- Removal of any vandalised, unhealthy or dead trees and replacement with plants of the same specification, during the next available planting season.

#### Ongoing Maintenance

Following initial establishment, Estates maintenance contractors will undertake the following operations as necessary during years 3 to 12+ after planting:

- The formative pruning of specimens to achieve optimum growth rates and maintain a shape, clear of any vehicular or pedestrian circulation routes;
- Maintenance of a 1.2m diameter weed free area around the base of each tree, through the application of a 75mm depth mulch, keeping a 200mm diameter at the base of the bole free of mulch to prevent basal rot of the bole. Additional spot treatment of herbicide or hand weeding if necessary to ensure the base of the tree is weed free till year 3;
- Treatment against pests and diseases with spraying and dusting;
- Inspection, adjustment and maintenance of guards, stakes, anchors and ties;
- Adjustment, re-firming and replacing guys, stakes and ties. Replace broken or missing items, adjust if necessary to allow for growth and prevent rubbing of bark;
- Re-firming of plants after strong winds, frost heave or other disturbances; and
- The removal of redundant guards, stakes and ties at appropriate times to ensure the optimum health of trees.
- Removal of any vandalised, unhealthy or dead trees and replacement with plants of the same specification, during the next available planting season until year 5.

### Specimen Shrub, Ornamental Shrub and Groundcover Planting

#### Establishment Maintenance

To ensure the successful establishment of these planting areas, the Contractors will undertake the following operations as necessary during the first 12 months after planting:

- Application of a glyphosphate based herbicide to shrub planting areas and additional hand weeding of planting beds during the first year to ensure beds are free of weed growth.;
- Annual replenishment of mulch to contract levels;
- Application of a slow release fertiliser to ensure soil fertility is maintained at appropriate levels;
- Treatment against pests and diseases with spraying and dusting;
- Pruning of shrubs for floral, foliage and stem colour effect and to remove weak, dead and diseased branches;
- Pruning of species to ensure correct form;
- Pruning of species to promote flowering/berry production/retention (where appropriate);
- Training and tying of wall shrubs and climbers to walls / frames;
- Remove dead growth and trim herbaceous perennial plants, avoiding damage to any new shoots that have emerged;
- Remove litter and deleterious material;
- Fork over beds as necessary to keep soil loose, with gentle cambers and no hollows. Take care not to reduce depth or effect of mulch;
- Re-firm plants after heavy winds, frost or other disturbances;
- Maintain and replace frames and ties;
- Watering of plants to ensure moisture levels are maintained appropriate for optimum growth; and
- Remove any vandalised, unhealthy, dead or short-living plants (as soon as possible) and replace with plants of a similar size to those adjacent, during the next available planting season.

#### Ongoing Maintenance

Following initial establishment, Estates maintenance contractors will undertake the following operations as necessary during years 2 to 12+ after planting.

- Application of a glyphosphate based herbicide to shrub planting areas and additional hand weeding of planting beds are free of weed growth till year 5;
- Annual replenishment of mulch to contract levels till year 3;
- Application of a slow release fertiliser to ensure soil fertility is maintained at appropriate levels;
- Treatment against pests and diseases with spraying and dusting;
- Pruning of shrubs for floral, foliage and stem colour effect and to remove weak, dead and diseased branches;
- Pruning of species to ensure correct form;
- Pruning of species to promote flowering/berry production/retention (where appropriate);
- Training and tying of wall shrubs and climbers to walls / frames;



### Specimen Shrub, Ornamental Shrub and Groundcover Planting

- Remove dead growth and trim herbaceous perennial plants, avoiding damage to any new shoots that have emerged;
- Remove litter and deleterious material;
- Fork over beds as necessary to keep soil loose, with gentle cambers and no hollows. Take care not to reduce depth or effect of mulch till year 3;
- Maintain and replace frames and ties;
- Watering of plants to ensure moisture levels are maintained appropriate for optimum growth till year 3;
- Heavy pruning of overgrown shrubs and climbers;
- The selective removal of shrubs and other plants from planting beds;
- Removal of ornamental plants that are losing aesthetic appeal and/or function and replace; and
- Remove any vandalised, unhealthy, dead or short-living plants (as soon as possible) and replace with plants of a similar size to those adjacent, during the next available planting season until year 5.

### Formal Hedgerow Planting

#### **General Maintenance**

Contractor will undertake the following operations within the first 12 months after planting then throughout the life of the development:

- Application of a glyphosphate based herbicide and additional hand weeding as necessary to maintain a 1m diameter weed free area around the base of hedgerow;
- Treatment against pests and diseases with spraying and dusting;
- Annual replenishment of mulch to contract levels;
- Application of a slow release fertiliser around the base of hedgerow plants to ensure soil fertility is maintained at appropriate levels;
- Trimming to encourage sound bushy growth, avoid large bare areas at the base and to maintain an attractive, consistent and densely clipped form;
- Fork over hedge trenches as necessary to keep soil loose, with gentle cambers and no hollows. Take care not to reduce depth or effect of mulch;
- Re-firm plants after heavy winds, frost or other disturbances;
- Remove litter and deleterious material;
- Trimming to a height not exceeding 1.2m with vertical sides;
- Maintain and replace grow tubes and timber stakes;
- Watering of plants to ensure moisture levels are maintained appropriate for optimum growth; and
- Remove any vandalised, unhealthy or dead plants and replace with plants of a similar size to those adjacent, during the next available planting season.

### Formal Hedgerow Planting

#### **Ongoing Maintenance**

Following initial establishment, Estates maintenance contractors will undertake the following operations as necessary during years 2 to 12+ after planting.

- Application of a glyphosphate based herbicide to formal hedgerows and additional hand weeding of hedges to ensure free of weed growth till year 5;
- Annual replenishment of mulch to contract levels till year 3;
- Treatment against pests and diseases with spraying and dusting;
- Application of a slow release fertiliser around the base of hedgerow plants to ensure soil fertility is maintained at appropriate levels;
- Remove litter and deleterious material;
- Watering of hedge to ensure moisture levels are maintained appropriate for optimum growth till year 3;
- Trimming to a height not exceeding 1.2m with vertical sides; and
- Remove any vandalised, unhealthy, dead or short-living plants (as soon as possible) and replace with plants of a similar size to those adjacent, during the next available planting season until year 5.

## Structure Planting

### Woodland and Understorey Planting

#### **Establishment Maintenance**

To ensure the successful establishment of woodland and understorey planting areas, Contractors will undertake the following operations as necessary during the first 12 months after planting:

- Maintain the woodland and understorey planting weed free, through the application of a translocated herbicide;
- Mulch to tree planting locations within woodland planting annual replenishment of mulch to contract levels;
- In high profile areas adjoining infrastructure corridors annual replenishment of mulch to contract levels;
- Spot treatment of pernicious weeds (e.g., brambles, etc) or undertake by hand if necessary;
- Treatment against pests and diseases with spraying and dusting;
- Application of a slow release fertiliser around the base of all woodland shrubs to ensure soil fertility is maintained at appropriate levels;
- Inspection, adjustment and maintenance of grow tubes, stakes and ties and make good as necessary;
- Re-firming of plants after strong winds, frost heave or other disturbances;
- Remove litter and deleterious material;
- Watering of plants to ensure moisture levels are maintained appropriate for optimum growth; and
- Removal of any vandalised, unhealthy or dead shrubs and replacement with plants of a similar size to those adjacent, during the next available planting season;

#### **Ongoing Maintenance:**

Following initial establishment, Estates maintenance contractors will undertake the following operations as necessary during years 2 to 12+ after planting.

- Maintain the woodland and understorey planting weed free, through the application of a translocated herbicide till year 5;
- Mulch to tree planting locations within woodland planting annual replenishment of mulch to contract levels till year 3;
- In high profile areas adjoining infrastructure corridors annual replenishment of mulch to contract levels till year 3;
- Spot treatment of pernicious weeds (e.g., brambles, etc) or undertake by hand if necessary;
- Treatment against pests and diseases with spraying and dusting;
- Application of a slow release fertiliser around the base of all woodland shrubs to ensure soil fertility is maintained at appropriate levels;
- Inspection, adjustment and maintenance of grow tubes, stakes and ties, make good as necessary until removed;
- Re-firming of plants after strong winds, frost heave or other disturbances;
- Remove litter and deleterious material;
- Watering of plants to ensure moisture levels are maintained appropriate for optimum growth till year 2;

### Woodland Understorey Planting

- Pruning to achieve optimum growth rates and maintain a good shape, clear of any vehicular or pedestrian circulation routes;
- Remove grow tubes, stakes and ties at appropriate times to ensure the optimum health of individual plants;
- Cleaning out and dead-wooding operations (as required);
- Thinning of planting to ensure a desirable woodland character (approximately every 10 to 15 years).
- Coppice 1/3 of Hazel stock on a 5 year rotational basis; and
- Removal of any vandalised, unhealthy or dead plants and replacement with plants of a similar size to those adjacent, during the next available planting season, until year 5.

### Native Hedgerow Planting

#### **Establishment Maintenance**

To ensure the successful establishment of Native Hedgerow planting, Contractors will undertake the following operations as necessary during the first 12 months after planting:

- Application of a glyphosphate based herbicide and additional hand weeding as necessary to maintain a 1m diameter weed free area around the base of hedgerow;
- Treatment against pests and diseases with spraying and dusting;
- Annual replenishment of mulch to contract levels;
- Application of a slow release fertiliser around the base of hedgerow plants to ensure soil fertility is maintained at appropriate levels;
- Trimming to encourage sound bushy growth, avoid large bare areas at the base and to maintain an attractive, consistent and densely clipped form;
- Fork over hedge trenches as necessary to keep soil loose, with gentle cambers and no hollows. Take care not to reduce depth or effect of mulch;
- Re-firm plants after heavy winds, frost or other disturbances;
- Remove litter and deleterious material;
- Trimming to a height not exceeding 1.2m with vertical sides;
- Maintain and replace grow tubes and timber stakes;
- Watering of plants to ensure moisture levels are maintained appropriate for optimum growth; and
- Remove any vandalised, unhealthy or dead plants and replace with plants of a similar size to those adjacent, during the next available planting season.

## Structure Planting

### Native Hedgerow Planting

#### Ongoing Maintenance

Following initial establishment, Estates maintenance contractors will undertake the following operations as necessary during years 2 to 12+ after planting.

- Application of a glyphosphate based herbicide to hedgerows and additional hand weeding of hedgerow to ensure free of weed growth till year 5;
- Annual replenishment of mulch to contract levels till year 3;
- Treatment against pests and diseases with spraying and dusting;
- Application of a slow release fertiliser around the base of hedgerow plants to ensure soil fertility is maintained at appropriate levels;
- Remove litter and deleterious material;
- Watering of hedge to ensure moisture levels are maintained appropriate for optimum growth till year 3;
- Trimming to encourage sound bushy growth, avoid large bare areas at the base and to maintain an attractive, consistent and densely clipped form;
- Remove grow tubes, stakes and ties at appropriate times to ensure the optimum health of individual plants;
- Trimming to a height not exceeding 1.8m where aligning infrastructure corridors and 2.5m in all other areas; and
- Remove any vandalised, unhealthy, dead or short-living plants (as soon as possible) and replace with plants of a similar size to those adjacent, during the next available planting season until year 5.

## Lagoon/ Swale Planting

### Establishment Maintenance

To ensure the successful establishment of Lagoon woodland and understorey planting areas, Contractors will undertake the following operations as necessary during the first 12 months after planting:

#### Buffer and Woodland Planting

- Maintain the woodland and understorey planting weed free, through the application of a translocated herbicide;
- Mulch to tree planting locations within woodland planting annual replenishment of mulch to contract levels;
- In high profile areas adjoining infrastructure corridors annual replenishment of mulch to contract levels;
- Spot treatment of pernicious weeds (e.g., brambles, etc.) or undertake by hand if necessary;
- Treatment against pests and diseases with spraying and dusting;
- Application of a slow release fertiliser around the base of all woodland shrubs to ensure soil fertility is maintained at appropriate levels;
- Inspection, adjustment and maintenance of grow tubes, stakes and ties and make good as necessary;
- Re-firming of plants after strong winds, frost heave or other disturbances;
- Remove litter and deleterious material;
- Watering of plants to ensure moisture levels are maintained appropriate for optimum growth; and
- Removal of any vandalised, unhealthy or dead shrubs and replacement with plants of a similar size to those adjacent, during the next available planting season;

#### Tree Planting

- Maintenance of a 1.2m diameter weed free area around the base of each tree, through the application of a 75mm depth mulch, keeping a 200mm diameter at the base of the bole free of mulch to prevent basal rot of the bole. Additional spot treatment of using a glyphosphate based herbicide only or hand weeding if necessary to ensure the base of the tree is weed free;
- Treatment against pests and diseases with spraying and dusting;
- Application of a slow release fertiliser around the base of all trees to ensure soil fertility is maintained at appropriate levels;
- Inspection, adjustment and maintenance of guards, stakes, anchors and ties;
- Adjustment, re-firming and replacing guys, stakes and ties. Replace broken or missing items, adjust if necessary to allow for growth and prevent rubbing of bark;
- Re-firming of plants after strong winds, frost heave or other disturbances;
- Watering of plants to ensure moisture levels are maintained appropriate for optimum growth; and
- Removal of any vandalised, unhealthy or dead trees and replacement with plants of the same specification, during the next available planting season.

### Ongoing Maintenance

Following initial establishment, Estates maintenance contractors will undertake the following operations as necessary during years 2 to 12+ after wood land planting and year 3 to 12+ for tree planting.

#### Buffer and Woodland Planting

- Maintain the woodland and understorey planting weed free, through the application of a translocated herbicide till year 5;
- Mulch to tree planting locations within woodland planting annual replenishment of mulch to contract levels till year 3;
- In high profile areas adjoining infrastructure corridors annual replenishment of mulch to contract levels till year 3;
- Spot treatment of pernicious weeds (e.g., brambles, etc.) or undertake by hand if necessary;
- Treatment against pests and diseases with spraying and dusting;
- Application of a slow release fertiliser around the base of all woodland shrubs to ensure soil fertility is maintained at appropriate levels;
- Inspection, adjustment and maintenance of grow tubes, stakes and ties, make good as necessary until removed;
- Re-firming of plants after strong winds, frost heave or other disturbances;
- Remove litter and deleterious material;
- Watering of plants to ensure moisture levels are maintained appropriate for optimum growth till year 2;
- Pruning to achieve optimum growth rates and maintain a good shape, clear of any vehicular or pedestrian circulation routes;
- Remove grow tubes, stakes and ties at appropriate times to ensure the optimum health of individual plants;
- Cleaning out and dead-wooding operations (as required);
- Thinning of planting to ensure a desirable woodland character (approximately every 10 to 15 years).
- Coppice 1/3 of Hazel stock on a 5 year rotational basis; and
- Removal of any vandalised, unhealthy or dead plants and replacement with plants of a similar size to those adjacent, during the next available planting season, until year 5.

#### Tree Planting

- The formative pruning of specimens to achieve optimum growth rates and maintain a shape, clear of any vehicular or pedestrian circulation routes;
- Maintenance of a 1.2m diameter weed free area around the base of each tree, through the application of a 75mm depth mulch, keeping a 200mm diameter at the base of the bole free of mulch to prevent basal rot of the bole. Additional spot treatment of herbicide or hand weeding if necessary to ensure the base of the tree is weed free till year 3;
- Treatment against pests and diseases with spraying and dusting;
- Inspection, adjustment and maintenance of guards, stakes, anchors and ties;
- Adjustment, re-firming and replacing guys, stakes and ties. Replace broken or missing items, adjust if necessary to allow for growth and prevent rubbing of bark;



- Re-firming of plants after strong winds, frost heave or other disturbances;
- The removal of redundant guards, stakes and ties at appropriate times to ensure the optimum health of trees; and
- Removal of any vandalised, unhealthy or dead trees and replacement with plants of the same specification, during the next available planting season until year 5.

## Marginal/ Aquatic Planting

### Ongoing Maintenance

- Remove from site all rubbish and debris from the entire surface of the waterbody, including any partially submerged items;
- Remove from site all invasive weeds from waterbodies by hand-weeding (digging, forking, hoeing or pulling);
- Clear 25% of marginal / aquatic vegetation (generally by hand-pulling, raking or netting) in order to retain areas of open water while at the same time maintaining some vegetation and structural variation. Ensuring that clearance is undertaken in strips across the full range of water depths and reducing the dominant species. arising should be left within 3m of the ponds for 3 hours before removal off site.
- Maintain clear of obstructive elements/ vegetation all inlets and outlets;
- Annually remove (as required) silt from the base of water channels; and
- Remove as required any obstructive elements within the swales to ensure a desirable character.

## Mown Grass sward

### Establishment Maintenance

To ensure the successful establishment of mown grass sward the Contractors will undertake the following operations as necessary during the first 12 months after sowing

- Contractors will undertake a 'first cut' once the grass has achieved an initial growth of 75mm. The sward will be mown to a height of 40mm and the mower shall have no roller and be sufficiently sharp to avoid root pulling.
- Edging off paths, hard surfaces and landscape beds prior to mowing;
- Hand weed to suppress perennial weeds on a monthly basis during the growing season;
- Water areas to ensure moisture levels are maintained appropriate to develop a healthy grass sward;
- Carefully dig out any residual perennial weeds such as docks; and
- Reinststate and repair failed, damaged, disturbed or worn areas;

### Ongoing Maintenance

Following initial establishment, Estates maintenance contractors will undertake the following operations as necessary during years 2 to 12+

- Mowing the established grass sward with a rotary machine to a height of 50mm, whenever the sward achieves a height exceeding 75mm;
- Edging off all paths and kerb edges prior to the mowing season;
- Frequent trimming (or herbicide control) of areas where grass abuts structures such as fences or walls, and around trees and obstacles;
- Watering of areas, using a fine rose spray, to ensure moisture levels are maintained appropriate to develop healthy sward growth;
- Application of spring and autumn fertiliser and overseeding;
- Reinstatement and repair of damaged or worn areas including ruts, molehills, etc. (to maintain a healthy and vigorous sward, free from disease, fungal growth, discolouration, scorch or wilt); and
- Application of a selective herbicide, suitable for suppressing perennial weeds.

## Wildflora & Damp Grassland

### Establishment Maintenance

To ensure the successful establishment of mown grass sward the Contractors will undertake the following operations as necessary during the first 12 months after sowing.

- Contractors will undertake a 'first cut' once the grass has achieved an initial growth of 75-100mm. The sward will be mown to a height of 50mm and the mower shall have no roller and be sufficiently sharp to avoid root pulling, leave cuttings to dry prior to removal.

### Ongoing Maintenance

Following initial establishment, Estates maintenance contractors will undertake the following operations as necessary during years 2 to 12+

- 2no. cut per annum of wild flora areas. Mowing to be undertaken at the middle and end of each growing season and to a height of 50mm;
- 2no. cut per annum of grassland areas (or more if required in order to maintain a Manning coefficient of 0.075). Mowing to be undertaken at the middle and end of each growing season and to a height of 50mm;
- Removing arisings from all areas following each cut, to ensure nutrient levels are kept to a minimum;
- The annual control of undesirable herbaceous species through the sensitive modification of mowing regimes, hand pulling or weed wiping/ spot spraying with herbicides;
- The cutting back at regular intervals (at least every 1-2 years) of any noxious weeds which establish within these areas;
- The re-sowing, and where necessary resolution of any underlying problems, of areas where grass/ flora swards fail to establish or die out.

## Existing Vegetation

### Existing Vegetation (to be retained)

#### General Maintenance

Existing vegetation will be subject to a high level of protection and monitoring to ensure their health is maintained throughout the life of the development. Contractors will (as required) undertake the following operations to existing trees to be retained:

- Selective pruning to ensure appropriate spacing in relation to screening requirements and the satisfactory development of the trees for their ecological value, without the trees becoming elongated as a result of overcrowding;
- Crown reduction, shaping, lifting and thinning (as required);
- Cleaning out and dead-wooding operations (as required);
- Thinning to ensure a desirable woodland character (approximately every 10 to 15 years); and
- Remove from site any arisings which result from works to existing trees.

All maintenance activities will be undertaken in accordance with BS3998 and be carefully monitored to eliminate undue stress. Contractors will comply with the current Forestry and Arboriculture Safety & Training Council (FASTCO) recommendations in relation to all aspects of the arboricultural works.

Maintenance Schedule

**Street Furniture**

**Maintenance Requirements**

Visual checks for superficial damage	1-12+	4x Annually	Jan	Apr	Jul	Oct
Repairs to street furniture	1-12+	As necessary	Within quarter reported			
Inspect and secure all fixtures and fittings	1-12+	4x Annually	Jan	Apr	Jul	Oct
Clean timber surfaces to remove Verdigris build up	1-12+	Annually	Jan	Apr	Jul	Oct
Remove splinters/ graffiti to timber surfaces	1-12+	4x Annually	Jan	Apr	Jul	Oct
Cleaning of metal surfaces	1-12+	4x Annually	Jan	Apr	Jul	Oct
Cleaning of concrete surfaces	1-12+	Annually	Jan	Apr	Jul	Oct

**Feature Planting**

**General Maintenance Requirements**

Spraying or dusting of trees against pests and diseases	1-5	As required	As recommended			
Application of fertiliser to base	1-5	Annually	Mar			
Inspection, adjustment and maintenance of stakes and ties	1-5	2 x Annually	Jan	Feb	Sep	Nov Dec
Replace damaged/ vandalised/ unhealthy stock	1-12+	Annually	Jan	Feb	Apr	May Jun Jul Aug Sep
Watering of area to ensure moisture levels are appropriate	1-5	As required	Apr May Jun Jul Aug Sep			
Removal of redundant guards, fencing, stakes and ties	2-12+	Annually	Jan	Apr	Jul	Oct
Removal of litter	1-12+	4x Annually	Jan	Apr	Jul	Oct

**Semi Mature, Extra Heavy Standard & Specimen Feathered Tree Planting**

Weed control around base of each tree	1-5	4x Annually	Jan	Mar	May	Jul	Sep
Re-firming of trees after strong winds	1-5	As required	All year				
Selective thinning for optimum growth	7-12+	Annually	Jan	Feb	Apr	May Jun Jul Aug Sep	
Formative pruning for optimum growth	7-12+	Every 10 years	Jan	Feb	Apr	May Jun Jul Aug Sep	

**Specimen Shrub, Ornamental Shrub and Groundcover Planting**

Hand weeding to control weed establishment	1-5	4x Annually	Jan	Mar	May	Jul	Sep
Herbicide treatment of shrub planting areas	2-5	3x Annually	Jan	Mar	May	Jul	Sep
Spot treatment of herbaceous areas	2-5	3x Annually	Jan	Mar	May	Jul	Sep
Replenishment of mulch	1-5	Annually	Jan	Mar	May	Jul	Sep
Formative pruning and removal of dead growth	1-12+	Annually	Jan	Feb	Apr	May Jun Jul Aug Sep	
Remove dead growth and trim herbaceous species	1-12+	Annually	Jan	Feb	Apr	May Jun Jul Aug Sep	
Selective thinning for optimum growth	7-12+	Annually	Jan	Feb	Apr	May Jun Jul Aug Sep	
Heavy pruning of overgrown shrubs and climbers	7-12+	Annually	Jan	Feb	Apr	May Jun Jul Aug Sep	

**Formal Hedgerow Planting**

Hand weeding to control weed establishment	1-5	2x Annually	Jan	Apr	Jul	Oct
Re-securing of weed suppressing fabric	1-5	Annually	Jan	Apr	Jul	Oct
Trimming of hedgerow to encourage bushy growth	1-5	2x Annually	Jan	Apr	Jul	Oct
Trimming of hedgerow to maintain height and clipped form	5-12+	2x Annually	Jan	Apr	Jul	Oct

**Structure Planting**

**General Maintenance Requirements**

Spraying or dusting of trees against pests and diseases	1-5	As required	As recommended			
Application of fertiliser to base	1-5	Annually	Mar			
Inspection, adjustment and maintenance of stakes and ties	1-5	2x Annually	Jan	Feb	Sep	Nov Dec
Replace damaged/ vandalised/ unhealthy stock	1-12+	Annually	Jan	Feb	Apr	May Jun Jul Aug Sep
Watering of area to ensure moisture levels are appropriate	1-5	As required	Apr May Jun Jul Aug Sep			
Removal of redundant guards, fencing, stakes and ties	2-12+	Annually	Jan	Apr	Jul	Oct
Removal of litter	1-12+	4x Annually	Jan	Apr	Jul	Oct

**Woodland Understorey Planting**

Weed control around the base of each plant	1-5	4x Annually	Jan	Feb	May	Jul	Sep
Spot treatment of pernicious weeds (e.g., Brambles)	1-5	4x Annually	Jan	Feb	May	Jul	Sep
Re-firming of plants after strong winds	1-5	As required	All year				
Selective thinning for optimum growth	7-12+	Annually	Jan	Feb	Apr	May Jun Jul Aug Sep	
Mowing of underlying grassed area	1-5	2x Annually	Jan	Feb	Apr	May Jun Jul Aug Sep	
Formative pruning of optimum growth and form	5-12+	Annually	Jan	Feb	Apr	May Jun Jul Aug Sep	

**Woodland Specimens**

Clearance of woodland shrubs	1-5	4x Annually	Jan	Feb	May	Jul	Sep
Weed control around base of each tree	1-5	4x Annually	Jan	Feb	May	Jul	Sep
Spot treatment of pernicious weeds (e.g., Brambles)	1-5	4x Annually	Jan	Feb	May	Jul	Sep
Re-firming of trees after strong winds	1-5	As required	All year				
Mowing of underlying grassed area	1-5	2x Annually	Jan	Feb	Apr	May Jun Jul Aug Sep	
Formative pruning for optimum growth	7-12+	Every 10 years	Jan	Feb	Apr	May Jun Jul Aug Sep	

**Native Hedgerow Planting**

Hand weeding to control weed establishment	1-5	2x Annually	Jan	Apr	Jul	Oct
Re-securing of weed suppressant fabric	1-5	Annually	Jan	Apr	Jul	Oct
Trimming of hedgerow to encourage bushy growth	1-5	Annually	Jan	Apr	Jul	Oct
Trimming of hedgerow to maintain height and clipped form	5-12+	Annually	Jan	Apr	Jul	Oct

**Lagoon Swale Planting**

**General Maintenance Requirements**

Spraying or dusting of trees against pests and diseases	1-5	As required	As Recommended											
Application of fertiliser to base	1-5	Annually	Mar											
Inspection, adjustment and maintenance of stakes and ties	1-5	2 x Annually	Jan	Feb	Sep	Nov Dec								
Replace damaged/ vandalised/ unhealthy stock	1-12+	Annually	Jan	Feb	Apr	May Jun Jul Aug Sep								
Watering of area to ensure moisture levels are appropriate	1-5	As required	Apr May Jun Jul Aug Sep											
Removal of redundant guards, fencing, stakes and ties	2-12+	Annually	Jan	Apr	Jul	Oct								
Removal of litter	1-12+	4x Annually	Jan	Apr	Jul	Oct								

**Lagoon/ Swale Shrub Planting**

Hand weeding to control weed establishment	1-5	2x Annually	Jan	Apr	Jul	Oct
Re-securing of weed suppressant fabric	1-5	Annually	Jan	Apr	Jul	Oct
Re-firming of trees after strong winds, frost heave, etc.	1-5	As required	All year			
Selective thinning to retain a dense brush character	3-12+	2x Annually	Jan	Feb	Apr	May Jun Jul Aug Sep
Formative pruning for optimum growth	5-12+	Annually	Jan	Feb	Apr	May Jun Jul Aug Sep

**Lagoon/ Swale Standard Trees**

Hand weeding to control weed establishment	1-5	2x Annually	Jan	Apr	Jul	Oct
Re-securing of weed suppressant fabric	1-5	Annually	Jan	Apr	Jul	Oct
Re-firming of trees after strong winds, frost heave, etc.	1-5	As required	All year			
Selective thinning to retain a dense brush character	3-12+	2x Annually	Jan	Feb	Apr	May Jun Jul Aug Sep
Formative pruning for optimum growth	7-12+	Every 10 years	Jan	Feb	Apr	May Jun Jul Aug Sep

**Marina/ Aquatic Planting**

Hand weeding to control weed establishment	1-5	2x Annually	Jan	Apr	Jul	Oct
Removal of obstructive elements	3-12+	4x Annually	Jan	Apr	Jul	Oct
Removal (as required) of excess silt	2-12+	Annually	Jan	Apr	Jul	Oct

**Grassland**

**General Maintenance Requirements**

Removal of litter	1-12+	4x Annually	Jan	Apr	Jul	Oct
-------------------	-------	-------------	-----	-----	-----	-----

**Mown Grass**

Mowing of grass with a rotary machine	1-12+	As required	Mar	Apr	May	Jun	Jul	Aug	Sep	Oct
Edging off paths and kerb edges	1-12+	Annually	Mar	Apr	May	Jun	Jul	Aug	Sep	Oct
Trimming of grass areas abutting structures	1-12+	As required	Mar	Apr	May	Jun	Jul	Aug	Sep	Oct
Replacement of damaged or worn areas	1-12+	Annually	Mar	Apr	May	Jun	Jul	Aug	Sep	Oct
Application of selective herbicide	1-12+	Annually	As Recommended							
Watering of area to ensure moisture levels are appropriate	1-5	As required	Apr	May	Jun	Jul	Aug	Sep	Oct	Nov Dec

**Wildflower & Damp Grassland**

Trimming of grass areas and removal of arisings	1-12+	2x Annually	Apr	May	Jun	Jul	Aug	Sep	Oct
Weed control to remove undesirable herbaceous species	1-5	2x Annually	Apr	May	Jun	Jul	Aug	Sep	Oct
Cutting back of pernicious weeds (e.g., Brambles)	1-5	Annually	Apr	May	Jun	Jul	Aug	Sep	Oct

**Existing Vegetation**

**Existing Vegetation (to be retained)**

Cleaning out, deadwooding and thinning	7-12+	Every 10 years	Jan	Feb	Apr	May Jun Jul Aug Sep
Crown reduction, shaping, lifting and thinning	7-12+	Every 10 years	Jan	Feb	Apr	May Jun Jul Aug Sep
Formative pruning for optimum growth	7-12+	Every 10 years	Jan	Feb	Apr	May Jun Jul Aug Sep
Removal of litter	1-12+	4x Annually	Jan	Apr	Jul	Oct

**Appendix 3:  
Terms of Reference for London Gateway Services Ltd**



## Appendix 3

### Terms of Reference for London Gateway Services Limited

#### Management Principles

The principle management aims of London Gateway Services Limited (LGSL) are to:

- achieve and consistently deliver a level of service and environment to occupiers that reflects a high quality value driven ethos;
- embrace the values of sustainable practices, relating to the environment, commercial objectives, social responsibilities, and the essential well-being of all personnel;
- maintain all elements for the long term benefit of the occupiers and their customers;
- seek continual improvement in the provision of services and management disciplines, bringing benefits to occupiers through the Park's adjacency to London Gateway port;
- achieve a secure, safe and world class logistics facility that enjoys long term success.

#### Management Details

The logistics park Estate will be managed in two principal zones, recognising the development programme and the sharing of certain services and infrastructure facilities. In addition, a third zone will be formed by the private Main Access Road owned by the London Gateway Port Limited.

LGSL will employ managers, facility personnel and administration staff directly, with all services and supplies procured through a strict contract regime that mirrors the corporate disciplines of DP World.

Principle areas of management activity will encompass:

- Park wide occupier engagement, promoting appropriate park community activities, key stakeholder engagement, and providing an estate management forum;
- Company administration, asset management, financial accounting and budgets, and sinking fund management;
- Utility supplies and distribution;
- Water management and drainage;
- Waste and recycling;
- Community networked building and services management system integration and monitoring;
- Landscape and physical environment management;
- Security; hard, observation and preventative regimes;
- Regulatory and statutory compliance, including health and safety;
- Communications and IT, infrastructure and park community network;
- General fabric maintenance and repairs and planned lifecycle maintenance regimes;
- Traffic management, wayfinding and intelligent mapping, travel plan support and co-ordination;
- Specialist services as required.

The LGSL management team recognises the value and quality ambitions of the London Gateway Logistics Park. The team will embrace best practice approach, with the objective to achieve a world class ethos through its provision and co-ordination of management routines and practices.

**Produced by  
Adams Hendry Consulting Ltd**

Sheridan House  
40-43 Jewry Street  
Winchester  
Hampshire  
SO23 8RY  
Tel: 01962 877414  
[www.adamshendry.co.uk](http://www.adamshendry.co.uk)